

3G LIGHTING

3G-PDL33RM3

3.3" MICRO MADISON CYLINDER
7" AND 11" HEIGHT



3.3" diameter high performance adjustable cylinders
1.2" Regressed LED source with enhanced glare control
Companion to 3G's Madison product family
Machined aluminum trim features 3G's Micro Madison double gimbal
Extruded aluminum housing with powder coated finish
Lumen range up to 1000lm (80+, 90+, and 97+ CRI options)
1% dimming standard with integral driver options

PROJECT:		TYPE:	
CATALOG#:		DATE:	QTY:

CAT. NO	FIXTURE HEIGHT	LUMEN OUTPUT	CRI	COLOR TEMP	BEAM ANGLE
3G-PDL33RM3	7H - 7" HEIGHT	07 - 700 LUMENS *	S80 - 80+ CRI ¹	27K - 2700K	30D - 30°
	11H - 11" HEIGHT	10 - 1000 LUMENS	H90 - 90+ CRI	30K - 3000K	45D - 45°
			H97 - 97+ CRI ¹	35K - 3500K 40K - 4000K	65D - 65°

*700 lumens not available in 7H fixture height

VOLTAGE	DRIVER	HOUSING FINISH	GIMBAL FINISH
UNV - 120/277V 120 - 120V	DIM - 0-10V (100-1%) LE - PHASE DIM ² (TRIAC/ELV, 100-1%)	WH - WHITE BK - BLACK SV - SILVER CF - CUSTOM RAL COLOR	NG - NATURAL ALUMINUM BG - BLACK WG - WHITE

CANOPY	SUSPENSION TYPE	SUSPENSION LENGTH	OPTIONS
WCN - WHITE (STANDARD) BCN - BLACK SCN - SILVER CFW - WHITE CONDUIT FEED CANOPY CFB - BLACK CONDUIT FEED CANOPY CFS - SILVER CONDUIT FEED CANOPY	WC - WHITE CABLE BC - BLACK CABLE RSW - WHITE RIGID STEM RSB - BLACK RIGID STEM RSS - SILVER RIGID STEM RSC - CUSTOM RAL STEM	C60 - 60" CABLE C120 - 120" CABLE S48 - 48" STEM S96 - 96" STEM	SF - SOFTENING LENS * HXB - BLACK HEXCELL LOUVER *

All suspension options are field cuttable

*Maximum 1 optical accessory

¹ S80 not available in 27K. H97 available in 30K and 35K as standard

² Phase dimming options available in 120V only

BASED ON 65° BEAM ANGLE AND 3500K SOURCE

LUMEN OUTPUT	80+ CRI			90+ CRI			97+ CRI		
	DELIVERED LUMENS	SYSTEM WATTS	EFFICACY (LPW)	DELIVERED LUMENS	SYSTEM WATTS	EFFICACY (LPW)	DELIVERED LUMENS	SYSTEM WATTS	EFFICACY (LPW)
700LMs	729	6.5	112	642	6.5	99	598	6.5	92
1000LMs	1057	9.3	114	930	9.25	101	866	9.25	94

LUMEN OUTPUT MULTIPLIER: 27K=0.94, 30K=0.97, 35K=1.00, 40K=1.01

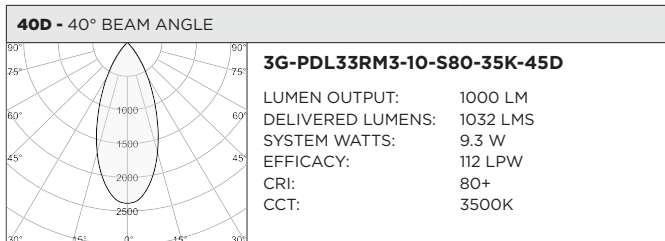
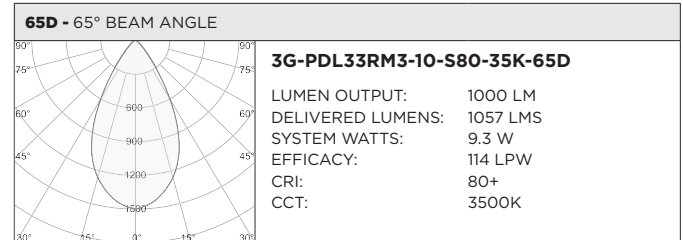
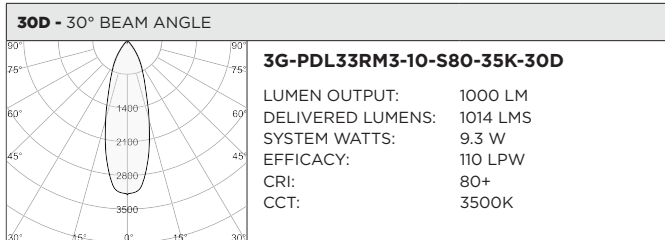

HOUSING

Extruded aluminum housing with powder coated finish

BEVELED INSERT

3.3" machined aluminum trim insert feature 3G's Micro Madison double gimbal
 Solid aluminum 30mm double gimbal with dual axis adjustability (35°x35°)

OPTICS

Regressed LED source for enhanced glare control
 Proprietary, high performance reflectors. Field replaceable
 Available in 30°, 45°, and 65°

MOUNTING

1/2" diameter rigid stem option with sloped ceiling adapter (field cuttable)
 Standard, 18-gauge, 5 conductor single circuit braided power feed (black and white finish)
 All hardware included for mounting to 4" octagonal junction box
 Canopy provided in white finish as standard
 Conduit feed cut-out canopy option designed to mount to 4" octagonal junction box

WARRANTY

5 Year Warranty on LED and drivers
 Manufacturer 1 Year Warranty for defects in material and workmanship under normal use
 Ambient temperature at fixture should not exceed 25°C

ELECTRICAL

Standard 0-10V, constant current drivers with 100-1% dimming range and >0.9 power factor
 Standard 120/277V universal voltage drivers
 120V Forward Phase/Reverse Phase option with 100-1% dimming range
 All drivers are integral and easily accessible through fixture aperture
 7" models include 0-10V drivers that operate only with dimmers that sink current (not designed for source current)
 Compatible 0-10V dimmers for all 7" height models listed below:
 Lutron NFTV, Lutron DVTV, Lutron DVSTV, Lutron VIVE RMJS-8TN, Leviton IP710-DLZ, Philips SR1200ZTUNV, Cooper SF10P

LED SYSTEM

Citizen LED module (field replaceable)
 Color consistency <2 SDCM
 Standard (80+ CRI). Optional (90+ and 97+ CRI)
 Available in 27K, 30K, 35K, and 40K
 L90 >50,000 hours
 5 Year Warranty

LISTING

ETL listed and conforms to UL1598 standard. Certified to CSA22.2 No.250.0.
 Rated for indoor dry or damp locations

RECESSED 4" OCTAGONAL JUNCTION BOX BY OTHERS
STANDARD CANOPY MOUNT

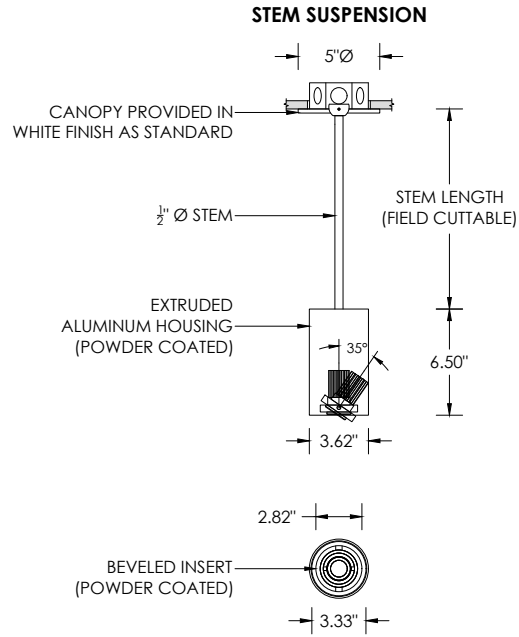
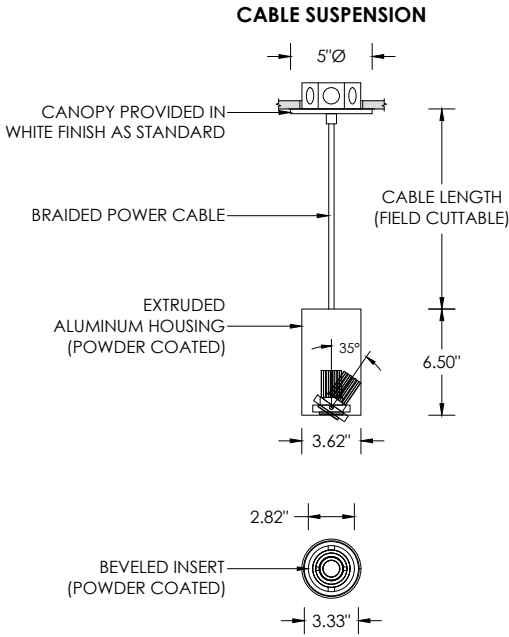

SUITABLE FOR SLOPED CEILING

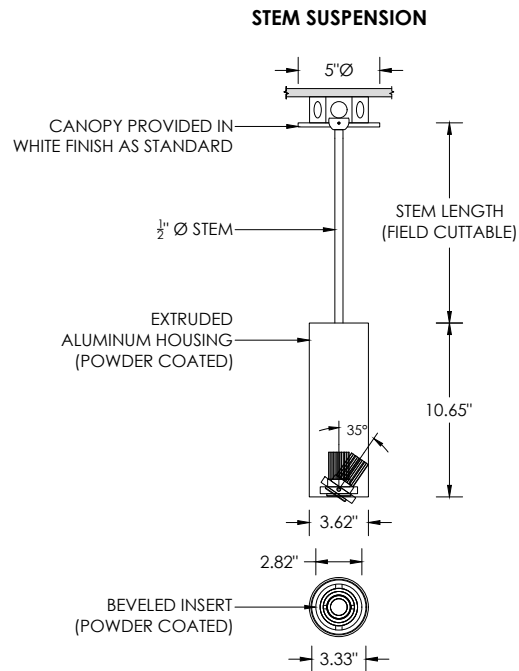
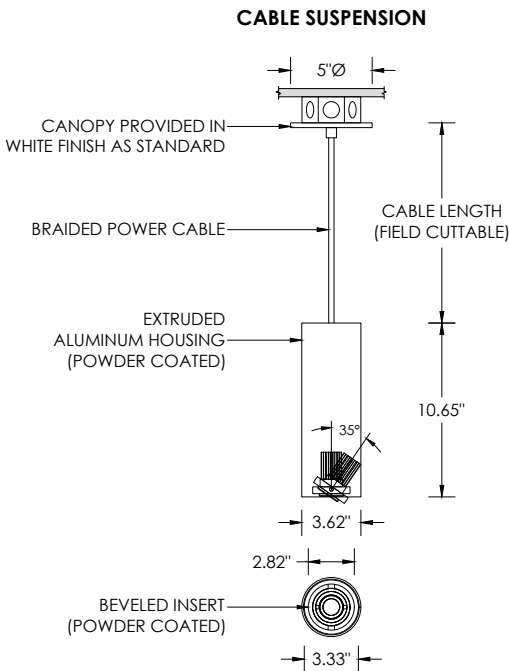
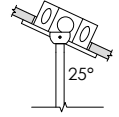

SUITABLE FOR SLOPED CEILING

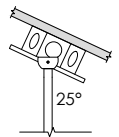

SURFACE 4" OCTAGONAL X 1.5" DEEP JUNCTION BOX BY OTHERS
CONDUIT FEED CANOPY MOUNT (CFX OPTION)

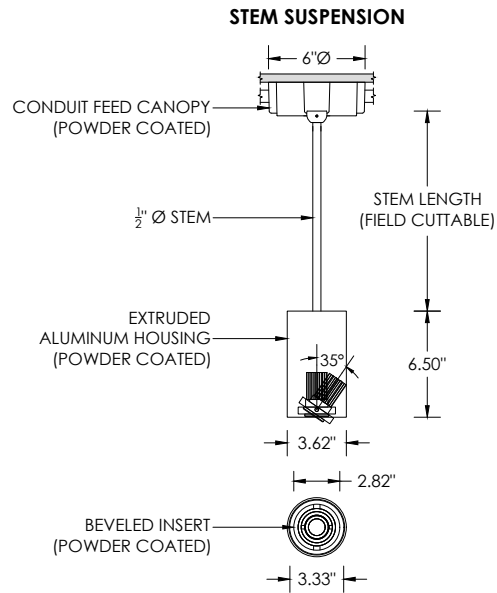
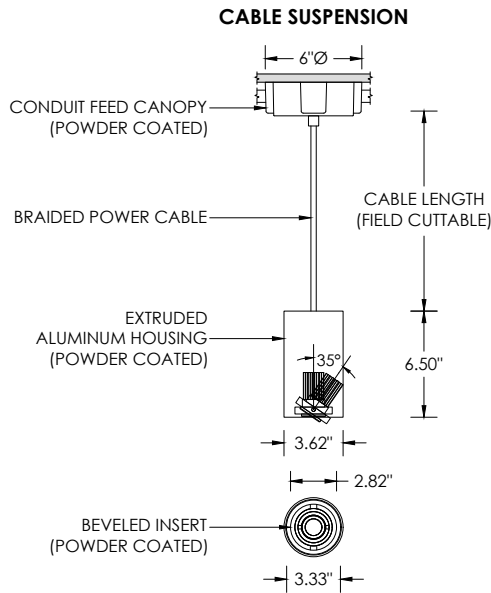

SUITABLE FOR SLOPED CEILING

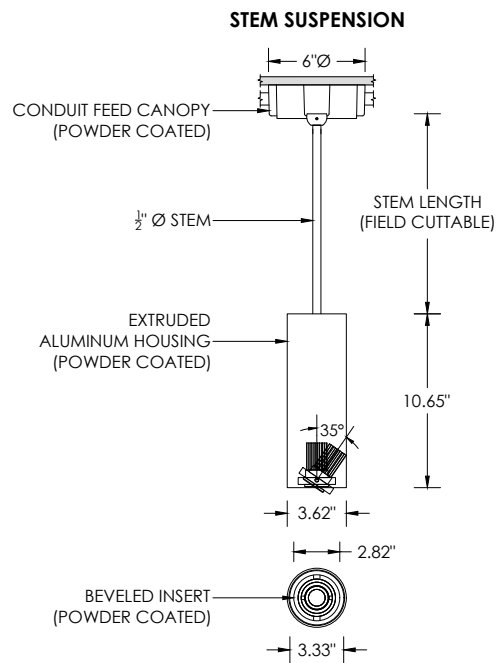
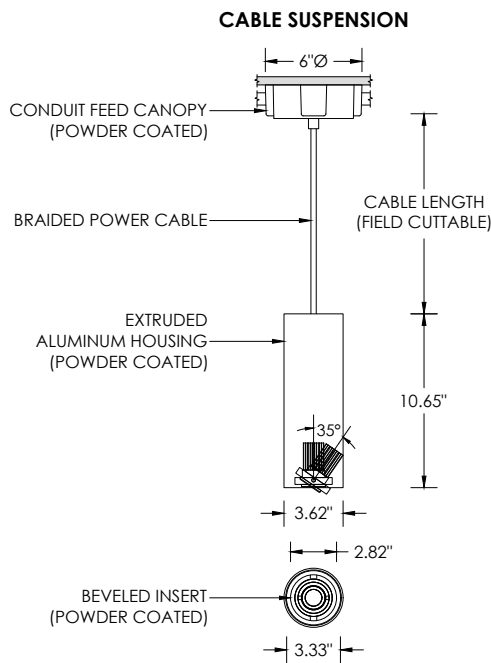
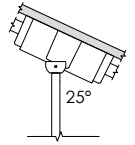

SUITABLE FOR SLOPED CEILING

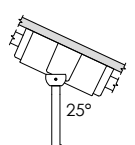

CONDUIT FEED CANOPY MOUNTING OPTIONS

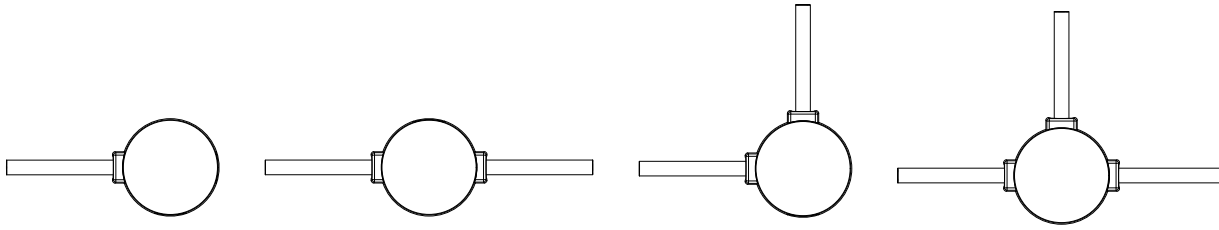

CONDUIT COVER
3 PROVIDED WITH EACH
CONDUIT FEED CANOPY

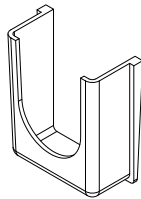

BLANK
2 PROVIDED WITH EACH
CONDUIT FEED CANOPY

