

# 3G LIGHTING

## 3G-SDL33SF

3.3" SURFACE DOWNLIGHT  
7" AND 11" HEIGHT  
DYNAMIC WHITE

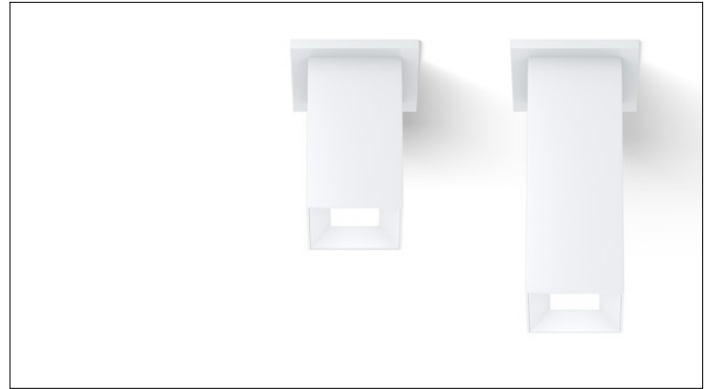

3.3" high performance downlight surface mounts  
Companion to 3G-DL33S series downlight family  
Extruded aluminum housing with powder coated finish  
Twist and lock construction and no visible hardware  
Regressed LED source for enhanced glare control  
Dim to Warm and Tunable White LED options up to 2000lm (90+ CRI)  
1% dimming standard with several integral driver options

**3GD 3GT**

<b>PROJECT:</b>		<b>TYPE:</b>	
<b>CATALOG#:</b>		<b>DATE:</b>	<b>QTY:</b>

CAT. NO	FIXTURE HEIGHT	LED SOURCE	LUMEN OUTPUT	CRI	BEAM ANGLE
<b>3G-SDL33SF</b>	<b>7H</b> - 7" HEIGHT * <b>11H</b> - 11" HEIGHT	<b>DW</b> - DIM TO WARM (1800-3000K) <b>TW</b> - TUNABLE WHITE <sup>1</sup> (2700-6500K)	<b>08</b> - 800 LUMENS <b>12</b> - 1200 LUMENS <b>20</b> - 2000 LUMENS	<b>H90</b> - 90+ CRI	<b>20D</b> - 20° <sup>2</sup> <b>30D</b> - 30° <b>40D</b> - 40° <b>50D</b> - 50° <b>60D</b> - 60° <b>90D</b> - 90° *  *90D reflector supplied standard with lens
	<small>*7H available in Dim to Warm option only. Available in DIM and LE driver options only</small>				

VOLTAGE	DRIVER	HOUSING FINISH	INSERT FINISH
<b>UNV</b> - 120/277V <b>120</b> - 120V	<b>DIM</b> - 0-10V (100-1%) <b>LE</b> - PHASE DIM <sup>3</sup> (TRIAC/ELV, 100-1%) <b>D01</b> - 0-10V (100-0.1%) <sup>1</sup> <b>DALI</b> - DALI (100-1%) <sup>1,4</sup> <b>DHL2</b> - LUTRON HI-LUME (1% ECOSYSTEM) <b>DMX</b> - DMX (100-0%) <sup>1</sup> <b>RDIM</b> - REMOTE 0-10V (100-1%) <b>RLE</b> - REMOTE PHASE (TRIAC/ELV, 100-1%)	<b>WH</b> - WHITE <b>BK</b> - BLACK <b>SV</b> - SILVER <b>CF</b> - CUSTOM RAL COLOR	<b>WI</b> - WHITE <b>BI</b> - BLACK <b>SI</b> - SILVER <b>CI</b> - CUSTOM RAL COLOR

OPTIONS
<b>LS</b> - LINEAR SPREAD LENS <b>SB</b> - SANDBLASTED LENS <b>SF</b> - SOFTENING LENS (SUPPLIED STANDARD)
<small>Maximum 1 optical accessory only Not available with 90D reflector option</small>

- <sup>1</sup> Tunable White option not available in 7" height. Available with D01 DALI and DMX drivers
- <sup>2</sup> 20D reflector available with 800lm option only
- <sup>3</sup> Phase dimming options available in 120V only
- <sup>4</sup> DALI-2 (Type 6) provided as standard. Consult factory for DALI Type 8 option

**3GD** - Warm Dim  
**3GT** - Tunable White

BASED ON 60° BEAM ANGLE AND 3000K SOURCE

LUMEN OUTPUT	90+ CRI		
	DELIVERED LUMENS	SYSTEM WATTS	EFFICACY (LPW)
<b>800LMs</b>	N/A	N/A	N/A
<b>1200LMs</b>	1050	15.4	68
<b>2000LMs</b>	1473	23.2	63

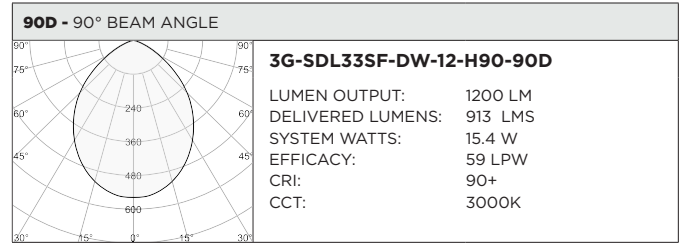
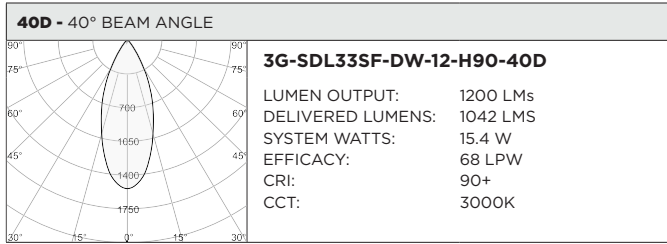
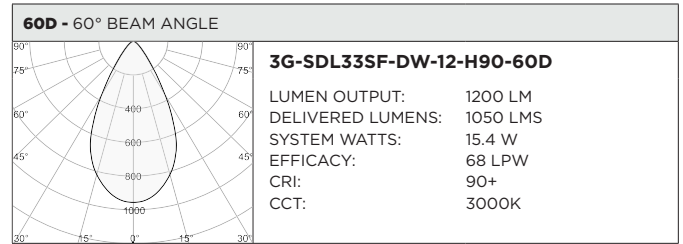
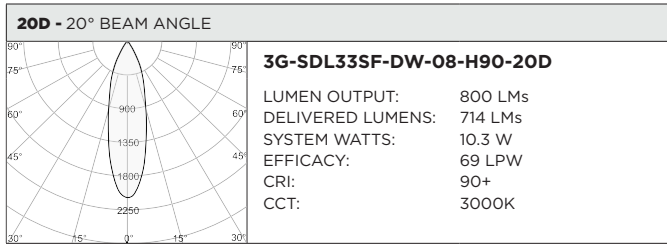

BASED ON 60° BEAM ANGLE AND 3500K SOURCE

LUMEN OUTPUT	80+ CRI			90+ CRI			97+ CRI		
	DELIVERED LUMENS	SYSTEM WATTS	EFFICACY (LPW)	DELIVERED LUMENS	SYSTEM WATTS	EFFICACY (LPW)	DELIVERED LUMENS	SYSTEM WATTS	EFFICACY (LPW)
<b>800LMs</b>	N/A	N/A	N/A	N/A	N/A	N/A	N/A	N/A	N/A
<b>1200LMs</b>	976	16.6	59	1047	16.6	63	1153	16.6	69
<b>2000LMs</b>	1407	24.5	57	1435	24.5	59	1679	24.5	69

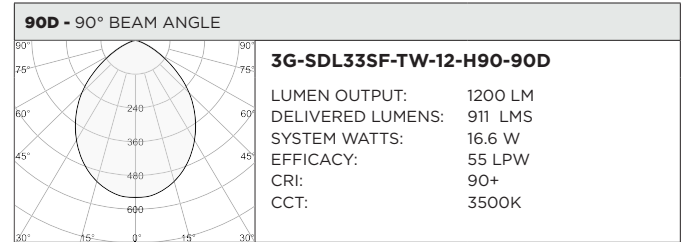
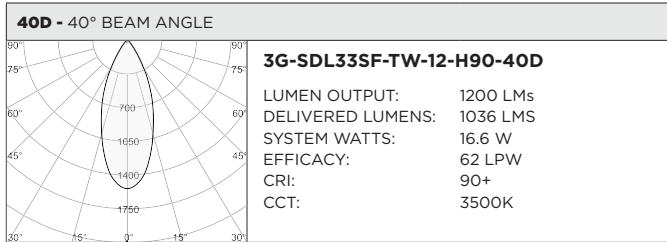
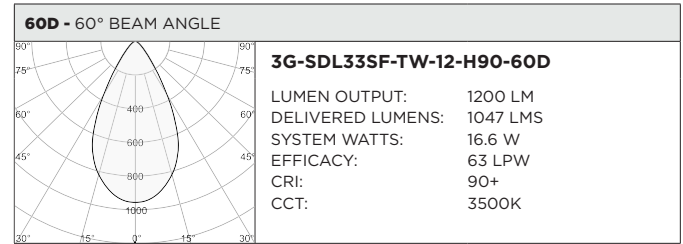
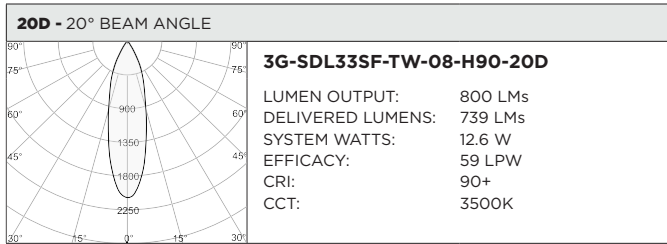

**HOUSING**

Extruded aluminum housing with powder coated finish  
Twist and lock construction with no visible hardware

**BEVELED INSERT**

3.3" aperture with regressed LED source for enhanced glare control  
Cast aluminum insert with matte powder coated finish

**OPTICS**

Proprietary anodized, aluminum reflectors are field replaceable (20° reflector not interchangeable)  
Available in 20°, 30°, 40°, 50°, 60° and 90°

**MOUNTING**

All hardware included for mounting to 4" octagonal junction box  
Twist and lock mechanism

**WARRANTY**

5 Year Warranty on LED and drivers  
Manufacturer 1 Year Warranty for defects in material and workmanship under normal use  
Ambient temperature at fixture should not exceed 25°C

**ELECTRICAL**

Standard 0-10V, constant current drivers with 100-1% dimming range and >0.9 power factor  
Standard 120/277V universal voltage drivers.  
120V Forward Phase/Reverse Phase driver option with 100-1% dimming range  
eldoLED 0-10V driver option available with 100-0.01% dimming range  
eldoLED DALI and Lutron EcoSystem driver options available with 100-1% dimming range  
DMX driver option available with 100-0% dimming range  
All drivers are integral and easily accessible through fixture aperture

**LED SYSTEM**

Bridgelux LED module (field replaceable)  
Color consistency <3 SDCM  
Standard 90+ CRI  
Dim to Warm (1800K-3000K)  
Tunable White (2700K-6500K)  
L70 >50,000 hours  
5 Year Warranty

**LISTING**

ETL listed and conforms to UL1598 standard. Certified to CSA22.2 No.250.0.  
Rated for indoor dry or damp locations

**RECESSED 4" OCTAGONAL JUNCTION BOX BY OTHERS**  
STANDARD CANOPY MOUNT

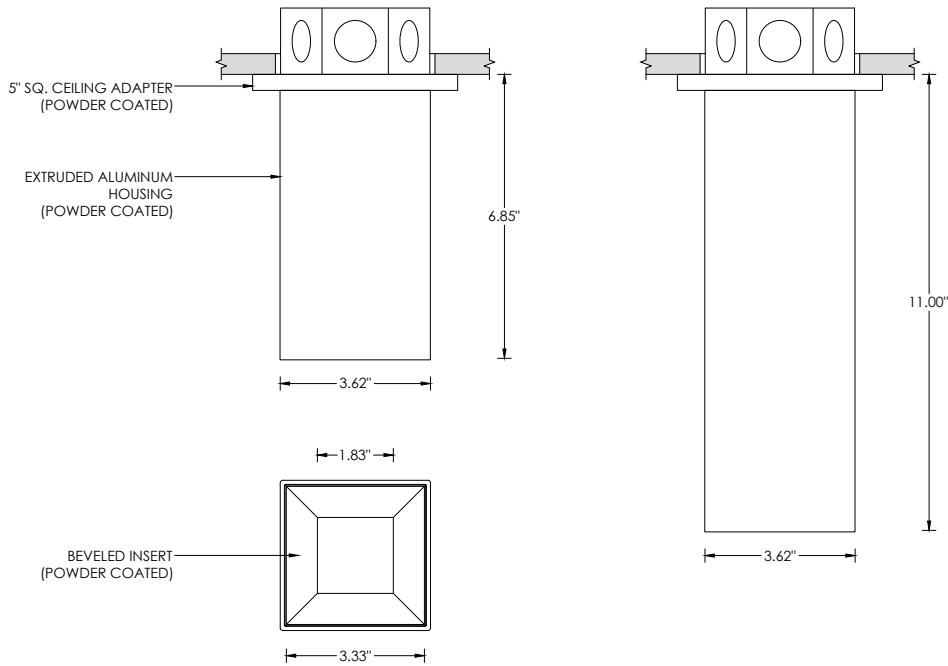

**RECESSED 4" OCTAGONAL JUNCTION BOX BY OTHERS**  
SEAMLESS CANOPY MOUNT (FXC OPTION) FOR NEW CONSTRUCTION ONLY

