

3G LIGHTING

3G-PMZ4

4 LIGHT LINEAR ZONE PENDANT

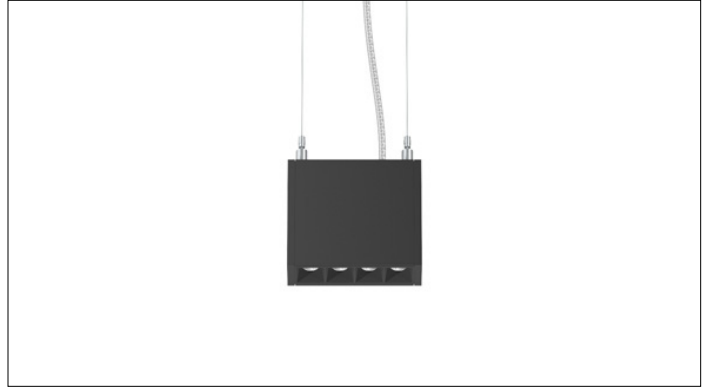

4 Light high performance pendant with 1" apertures
 Narrow 1.5" aperture with one piece extruded aluminum housing
 LED system delivers over 800lm at 90+ CRI
 Features matte black or matte white multi-faceted louvers
 Regressed LED source with enhanced glare control, UGR <16
 100-1% dimming range standard with remote drivers

PROJECT:		TYPE:	
CATALOG#:		DATE:	QTY:

CAT. NO	LUMEN OUTPUT	CRI	COLOR TEMP	BEAM ANGLE	VOLTAGE
3G-PMZ4	04 - 400 LUMENS 08 - 800 LUMENS	H90 - 90+ CRI	27K - 2700K 30K - 3000K 35K - 3500K 40K - 4000K	15D - 15° 35D - 35° 55D - 55°	UNV - 120/277V 120 - 120V

DRIVER	HOUSING FINISH	LOUVER FINISH	CABLE LENGTH
RDIM - REMOTE 0-10V (100-1%) RD01 - REMOTE 0-10V (100-0.1%) RDALI - REMOTE DALI (100-1%) RDHL2 - REMOTE LUTRON HI-LUME (1% ECOSYSTEM)	WH - WHITE BK - BLACK SV - SILVER <small>All mounting canopies provided in white as standard</small>	WLV - WHITE BLV - BLACK	60" - 60" 120" - 120"

1 Remote Lutron Hi-Lume Forward Phase driver (LTEA) available in 120V only

BASED ON 35°, 90+ CRI LED SOURCE

FIXTURE LENGTH	COLOR TEMP	DELIVERED LUMENS	SYSTEM WATTS	EFFICACY (LPW)
08 - 800 LUMENS	27K	684	9.6	71
	30K	745	9.6	78
	35K	822	9.6	86
	40K	838	9.6	88

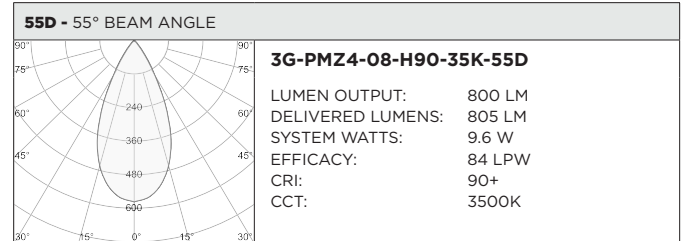
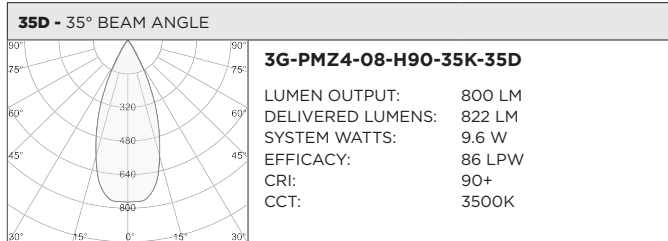

REMOTE POWER SUPPLY OPTIONS

3G DRIVER CODE	DIMMING METHOD	DIMMING RANGE	VOLTAGE	MAX. DISTANCE	3G-PMZ4 (9.6W)	3G-PMZ8 (19.2W)	3G-PMZ12 (28.5W)
RDIM	0-10V	100-1%	120-277V	100ft (12AWG)	1 to 4	1 to 2	1
RDHL2	LUTRON HI-LUME ECOSYSTEM	100-1%	120-277V	100ft (12AWG)	2 to 4	1 to 2	1
RDALI	DALI ELDOLED	100-1%	120-277V	100ft (12AWG)	1 to 4	1 to 2	1
RD01	0-10V ELDOLED	100-0.1%	120-277V	100ft (12AWG)	1 to 4	1 to 2	1

REMOTE POWER SUPPLY ENCLOSURE

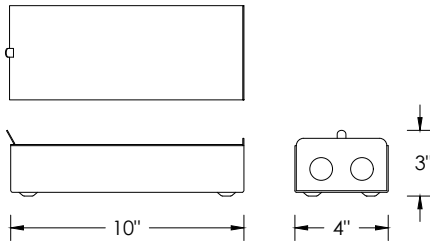

WIRING DIAGRAM

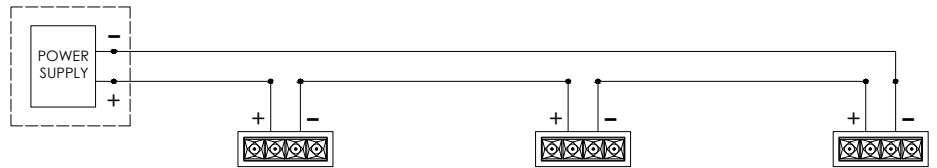

Multiple Zoie fixtures must be connected in series

HOUSING

Extruded aluminum housing with narrow 1.5" aperture
Machined aluminum end caps
Standard polyester powder coated housing finish available in matte white, black, and silver
Matte black and matte white faceted louver finishes

OPTICS

1" apertures with regressed LED source for enhanced glare control
Proprietary polycarbonate multi-faceted reflectors
Available in 15°, 35° and 55°
UGR <16

LISTING

ETL listed and conforms to UL1598 standard. Certified to CSA22.2 No.250.0. Rated for indoor locations

WARRANTY

5 year warranty on LED and drivers
Manufacturer 1 year warranty for defects in material and workmanship under normal use
Ambient temperature at fixture should not exceed 25°C

ELECTRICAL

Remote 0-10V, constant current driver with 100-1% dimming range
Remote 0-10V, constant current driver with 100-0.1% dimming range
Remote Lutron EcoSystem and eldoLED DALI options (100-1% dimming)

LED SYSTEM

Osram LED source
Color consistency <2 SDCM
Standard 90+ CRI
Available in 27K, 30K, 35K, and 40K
L90 >60,000 hours
5 year warranty

MOUNTING

Adjustable aircraft cable suspension with locking fasteners (60" length standard)
Standard, 18-gauge, 5 conductor single circuit power feed (clear braided finish)
All mounting canopies provided in white finish as standard
Suitable for various architectural ceilings (see mounting details)

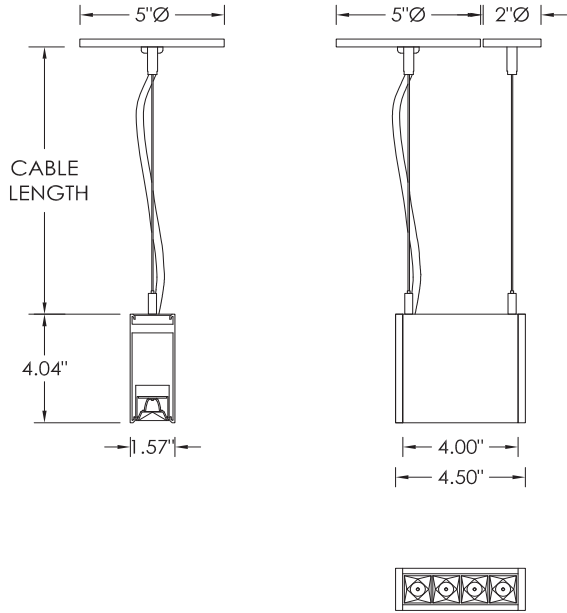

BEAM ANGLE

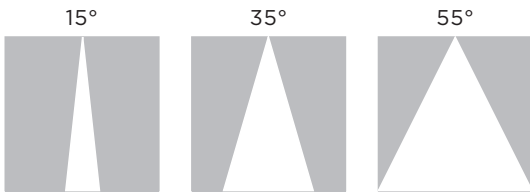

MOUNTING DETAILS

