



3G-RC1-5RD

5" ROUND MADISON
TRIM & TRIMLESS



New construction housing with IC housing option available
 Machined aluminum insert with seamless ceiling integration
 Trim fixture designed to conceal internal hardware
 Machined aluminum double gimbal. Adjustable and lockable
 2.75" Regressed LED source for enhanced glare control
 Lumen range up to 4000lm (80+, 90+, and 97+ CRI options)
 1% dimming standard with several integral driver options

PROJECT:		TYPE:	
CATALOG#:		DATE:	QTY:

CAT. NO	LUMEN OUTPUT	CRI	COLOR TEMP	BEAM ANGLE	VOLTAGE
3G-RC1-5RD	10 - 1000 LUMENS	S80 - 80+ CRI ¹	27K - 2700K	10D - 10° ²	UNV - 120/277V
	15 - 1500 LUMENS	H90 - 90+ CRI	30K - 3000K	20D - 20°	120 - 120V
	22 - 2200 LUMENS	H97 - 97+ CRI ¹	35K - 3500K	40D - 40°	347 - 347V ³
	30 - 3000 LUMENS		40K - 4000K	60D - 60°	
	40 - 4000 LUMENS			90D - 90° *	

*90D reflector supplied standard with lens

DRIVER	FLANGE TYPE	GIMBAL FINISH	HOUSING INTERIOR
DIM - 0-10V (100-1%) LE - PHASE DIM ⁴ (TRIAC/ELV, 100-1%) DO1 - 0-10V (100-0.1%) DALI - DALI (100-1%) ⁵ DHL2 - LUTRON HI-LUME (1% ECOSYSTEM) DMX - DMX (100-0%)	WT - WHITE TRIM ST - SILVER TRIM BT - BLACK TRIM CT - CUSTOM XTR - TRIMLESS (MUD-IN DRYWALL)	NG - NATURAL ALUMINUM BG - BLACK GIMBAL WG - WHITE GIMBAL	BK - BLACK

HOUSING TYPE	OPTIONS
NC - NEW CONSTRUCTION (NON-IC) IC - IC HOUSING ⁶	HXB - BLACK HEXCELL LOUVER LS - LINEAR SPREAD LENS PM - PRISMATIC LENS SF - SOFTENING LENS CP - CHICAGO PLENUM BH - C-CHANNEL BAR HANGERS EMR - EMERGENCY BATTERY ⁷ (REMOTE) Maximum 2 optical accessories. See optical accessories page for more options

¹ S80 not available in 27K. H97 available in 30K and 35K as standard and available up to 3000lm
² 10D reflector available up to 2200lm
³ 347 available in "DIM" 0-10V only (100-1%)
⁴ Phase dimming options available in 120V only
⁵ DALI-2 (Type 6) provided as standard. Please consult factory for DALI (Type 8) options
⁶ IC Housing available up to 2200lm
⁷ Emergency battery installed remotely by others. Not accessible through the inside of the fixture

BASED ON 20° BEAM ANGLE AND 3500K SOURCE

LUMEN OUTPUT	80+ CRI			90+ CRI			97+ CRI		
	DELIVERED LUMENS	SYSTEM WATTS	EFFICACY (LPW)	DELIVERED LUMENS	SYSTEM WATTS	EFFICACY (LPW)	DELIVERED LUMENS	SYSTEM WATTS	EFFICACY (LPW)
1000LMs	1080	10.3	105	951	10.3	92	886	10.3	86
1500LMs	1444	14.0	103	1271	14.0	91	1184	14.0	85
2200LMs	2089	22.0	95	1838	22.0	84	1713	22.0	78
3000LMs	2815	31.3	90	2477	31.3	79	2308	31.3	74
4000LMs	3958	43.0	92	3483	43.0	81	N/A	N/A	N/A

LUMEN OUTPUT MULTIPLIER: 27K=0.94, 30K=0.97, 35K=1.00, 40K=1.01

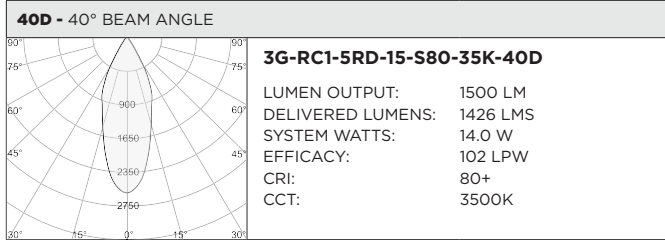
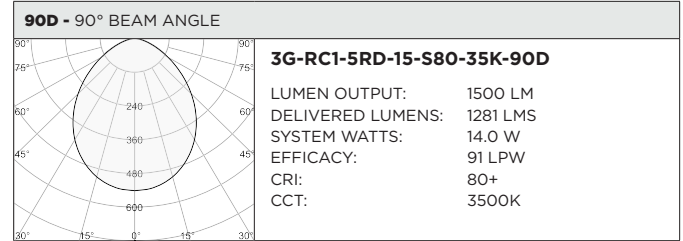
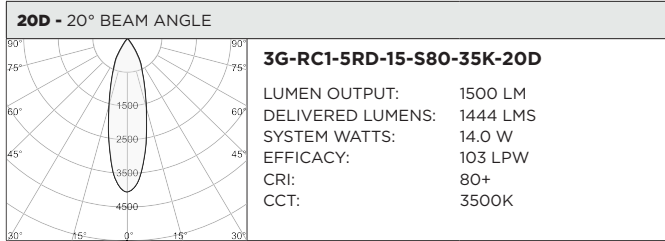
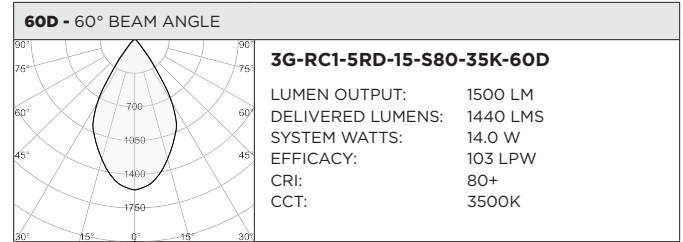
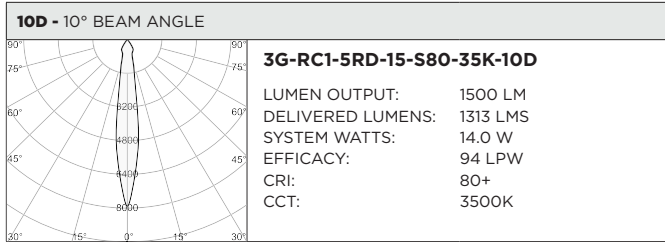

HOUSING

New construction housing with IC housing option available
Housing fabricated in cold rolled steel. Standard black powder coated finish
Maximum ceiling thickness of 1". Consult factory for modifications
All housing options designed to be easily converted in field to trim or trimless with minimal components
Housings are rated for #12 AWG, (4 in, 4 out), 90°C conductors and through branch wiring

TRIM

Features a 3/4" removable trim assembly designed to conceal inner hardware

TRIMLESS

Mudding flange with integral blocking support
Machined aluminum insert with seamless ceiling integration

ADJUSTABILITY

Solid aluminum double gimbal with dual axis adjustability
Each double gimbal can be locked in place

OPTICS

Regressed LED source for enhanced glare control
Proprietary anodized, aluminum reflectors are field replaceable (10° reflector not interchangeable)
Available in 10°, 20°, 40°, 60° and 90°

LISTING

ETL listed and conforms to UL1598 standard. Certified to CSA22.2 No.250.0.
Rated for indoor dry or damp locations

WARRANTY

5 Year Warranty on LED and drivers
Manufacturer 1 Year Warranty for defects in material and workmanship under normal use
Ambient temperature at fixture should not exceed 25°C

ELECTRICAL

Standard 0-10V, constant current drivers with 100-1% dimming range and >0.9 power factor
Standard 120/277V universal voltage drivers. Optional 347V, 0-10V drivers
120V Forward Phase/Reverse Phase driver option with 100-1% dimming range
eldoLED 0-10V driver option available with 100-0.01% dimming range
eldoLED DALI and Lutron EcoSystem driver options available with 100-1% dimming range
DMX driver option available with 100-0% dimming range
All drivers are integral and easily accessible through fixture aperture

LED SYSTEM

Citizen LED module (field replaceable)
Color consistency <2 SDCM
Standard (80+ CRI). Optional (90+ and 97+ CRI)
Available in 27K, 30K, 35K, and 40K
L90 >50,000 hours
5 Year Warranty

MOUNTING

Trim fixture designed for use in drywall, wood, acoustic ceiling tiles, and other architectural ceiling materials
Trimless fixture designed for use in drywall, mud-in ceiling applications
Butterfly brackets compatible with 1/2" x 1/2" channel, 1/2", 5/8", 3/4" bar hanger, 1/2" EMT, and furring strips (supplied by others)

TRIM HOUSING OPTIONS

- NC** - NEW CONSTRUCTION (NON-IC)
- IC** - IC HOUSING (2200LM MAX)
- CP** - CHICAGO PLENUM HOUSING

LUMEN OUTPUT	A	B
Up to 1500lm	45°	45°
2200lm/3000lm	35°	35°
4000lm	20°	30°

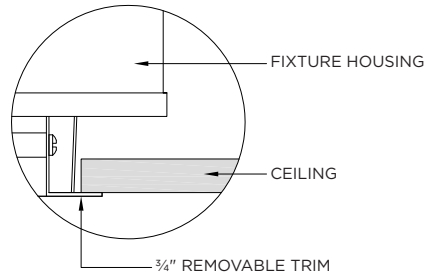
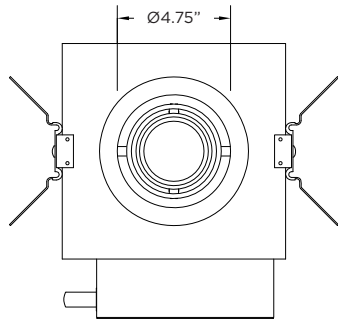
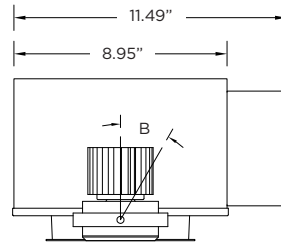
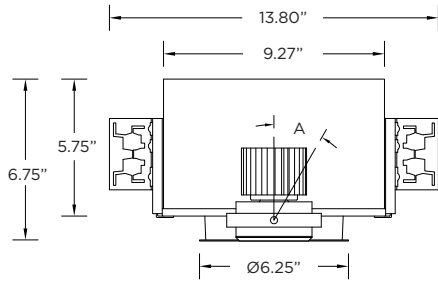

TRIMLESS HOUSING OPTIONS

- NC** - NEW CONSTRUCTION (NON-IC)
- IC** - IC HOUSING (2200LM MAX)
- CP** - CHICAGO PLENUM HOUSING

LUMEN OUTPUT	A	B
Up to 1500lm	45°	45°
2200lm/3000lm	35°	35°
4000lm	20°	30°

