

3G LIGHTING

3G-4PLI-D

3.5" LINEAR PENDANT
DIRECT

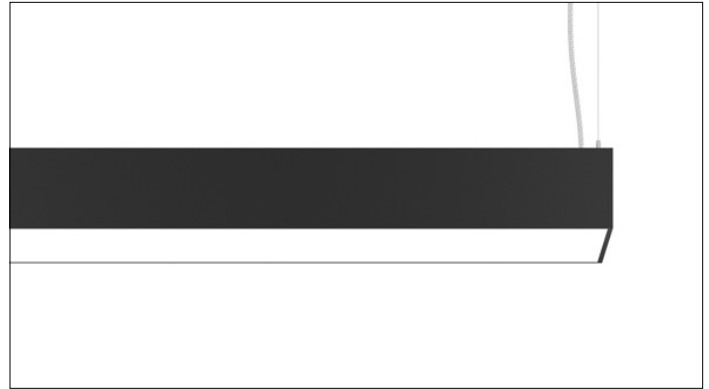

- 3.5" aperture with one piece extruded aluminum housing
- Individual or continuous runs available in multiple run configurations
- Direct distribution with multiple lumen output options
- LED system with performance up to 136 lumens per watt
- Extruded acrylic lens available in flush, 1" and 2" drop lens options
- Asymmetric optics available
- 1% dimming standard with several driver options



PROJECT:		TYPE:	
CATALOG#:		DATE:	QTY:

CAT. NO	LUMEN OUTPUT	CRI	COLOR TEMP	VOLTAGE
3G-4PLI-D	D250 - 250 LM/FT ¹ D500 - 500 LM/FT D750 - 750 LM/FT D1000 - 1000 LM/FT DC___ - CUSTOM OUTPUT (SPECIFY LM/FT) * <small>*Specify custom lumen outputs in 50lm increments (ie: DC600, DC650, DC700) Custom output cannot exceed D1000 DLC minimum lumen output is 500 lm/ft</small>	S80 - 80+ CRI ² H90 - 90+ CRI <small>*DLC listing available with 80CRI</small>	27K - 2700K 30K - 3000K 35K - 3500K 40K - 4000K <small>*DLC listing available with 35K</small>	UNV - 120/277V 347 - 347V ³

DRIVER	LENS OPTION	FINISH	CABLE LENGTH
DIM - 0-10V (100-1%) DO1 - 0-10V (100-0.1%) DALI - DALI (100-1%) ⁴ DHL2 - LUTRON HI-LUME (1% ECOSYSTEM) DMX - DMX (100-0%)	FL - FLUSH LENS DD1 - 1" DROP LENS ⁵ DD2 - 2" DROP LENS ⁵ DASY - ASYMMETRIC LENS	WH - WHITE BK - BLACK SV - SILVER <small>All mounting canopies provided in white as standard</small>	60 - 60" 120 - 120"

OPTIONS	RUN TYPE
EMB - EMERGENCY BATTERY * (INTEGRAL) EMC - EMERGENCY CIRCUIT MC2 - MULTIPLE CIRCUITS (2 ZONES) MC3 - MULTIPLE CIRCUITS (3 ZONES) <small>*Minimum 4' section</small>	S - ___' (STRAIGHT) * L - ___'X ___' (L-SHAPE) U - ___'X ___'X ___' (U-SHAPE) R - ___'X ___' (RECTANGLE/SQUARE) T - ___'X ___' (T-SHAPE) X - ___'X ___' (X-SHAPE) CUS - ___ (CUSTOM LAYOUT - PROVIDE DRAWING) <small>*Individual units available from 2' to 8' Continuous runs available in 1" increments as standard</small>

1 D250 (250LM/FT) not available in 2' length with DALI, DO1, DMX, or DHL2. Specify minimum DC350 for those driver options
 2 S80 (80+ CRI) not available with 27K and 40K
 3 347 available in "DIM" 0-10V only (100-1%)
 4 DALI-2 (Type 6) provided as standard. Please consult factory for DALI (Type 8) options
 5 DD1 (1" drop lens) and DD2 (2" drop lens) available with straight run type only



DLC listing starting at 500 lumens per foot (D500)
Available with 80CRI and 3500K

BASED ON 4' LENGTH (80+ CRI AND 3500K SOURCE)

LENS OPTION	DELIVERED LUMENS (LM/FT)	SYSTEM WATTS (W/FT)	EFFICACY (LPW)
FLUSH	250	1.9	129
	500	3.9	129
	750	6.0	127
	1000	8.1	123
1" DROP	250	1.9	133
	525	3.9	134
	775	6.0	132
	1025	8.1	128
2" DROP	275	1.9	136
	525	3.9	136
	800	6.0	134
	1050	8.1	129
ASYMMETRIC	250	1.9	131
	500	3.9	132
	750	6.0	128
	1000	8.1	124

LUMEN OUTPUT MULTIPLIER: 27K=0.94, 30K=0.97, 35K=1.00, 40K=1.01, 90CRI=0.88

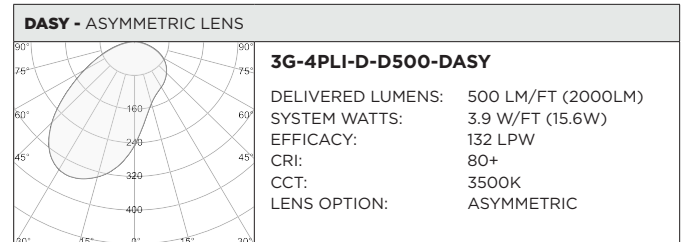
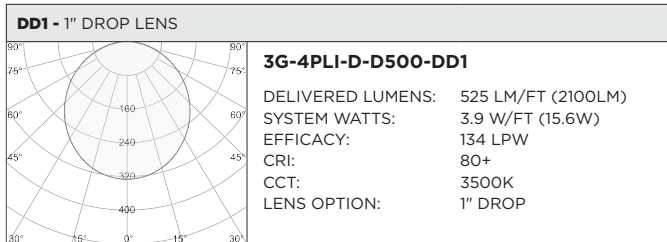
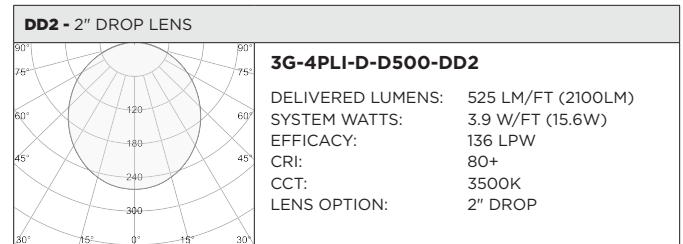
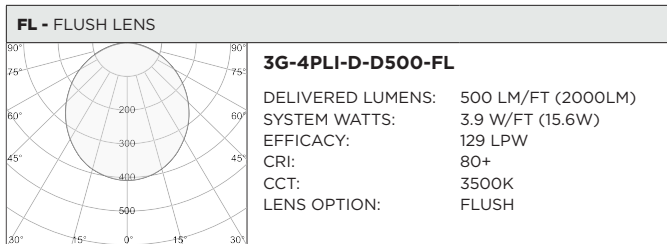

HOUSING

Extruded aluminum housing with narrow 3.5" aperture
Die cast aluminum end caps add 1/4" to each end of luminaire
Individual units and continuous runs available in 1" increments as standard
24-gauge LED reflector with high reflectance white powder coated finish
Standard polyester powder coated matte white finish. Optional finishes available

OPTICS

Extruded, satin acrylic lens designed for optimal performance and glare control. Up to 8' continuous
Lens options include flush, 1" and 2" drops with illuminated end caps for all drop lenses
High performance asymmetric optics available

LISTING

ETL listed and conforms to UL1598 standard. Certified to CSA22.2 NO.250.0. Rated for indoor dry or damp locations
DLC certified. Consult factory for details

WARRANTY

5 Year Warranty on LED and drivers
Manufacturer 1 Year Warranty for defects in material and workmanship under normal use
Ambient temperature at fixture should not exceed 25°C

ELECTRICAL

Standard 0-10V, constant current drivers with 100-1% dimming range and >0.9 power factor
Standard 120/277V universal voltage with several driver options
Luminaires are pre-wired with factory installed quick connects and branch circuit wiring
All drivers are integral and easily accessible through luminaire aperture
Minimum 4' and maximum 6' length for each integral emergency battery. 10W output for 90 minutes

LED SYSTEM

Proprietary LED system with color consistency <3 SDCM
Available in 27K, 30K, 35K, and 40K
Standard 80+CRI. Optional 90+CRI
R9 value of 56 for 90+CRI
L90 >60,000 hours
5 Year Warranty

MOUNTING

Toolless installation with 3G's proprietary mounting system
Internal, toolless joiner system (latch and hook) easily connects multiple sections together
LED reflectors remain within each fixture section during installation with 3G's click and lock spring system
Adjustable aircraft cable suspension with locking fasteners (60" length standard)
Standard, 18-gauge, 5 conductor single circuit power feed (clear braided finish)
All mounting canopies provided in white finish as standard
Suitable for various architectural ceilings (see mounting details)
Fixture weight: +/- 3 lb/ft

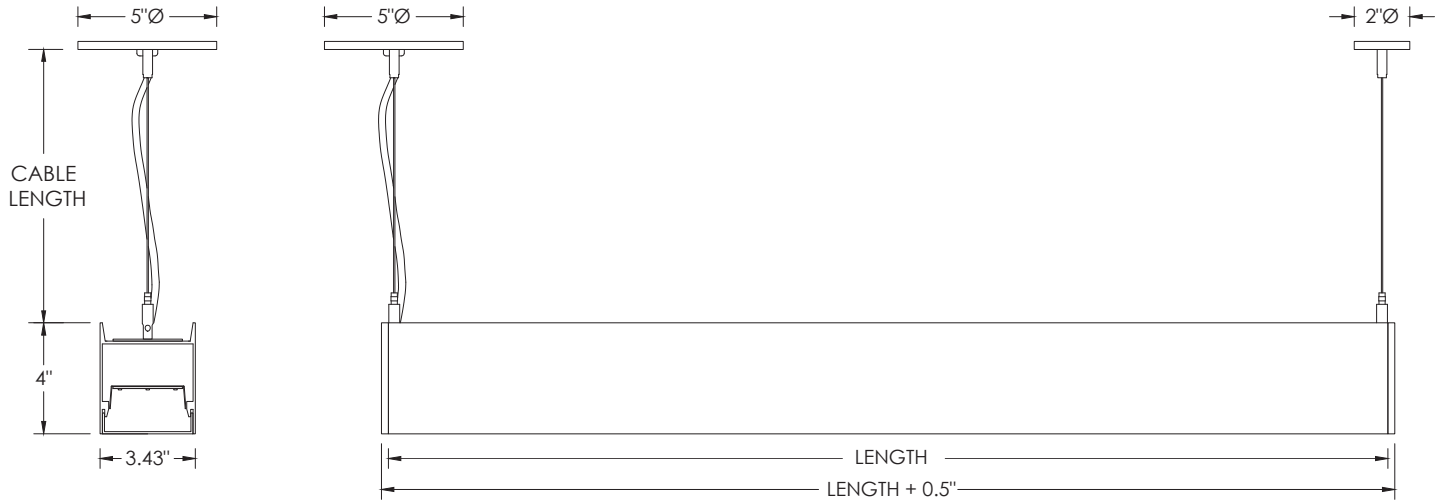

LENS OPTION

FL - FLUSH

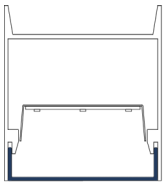

DD1 - 1" DROP

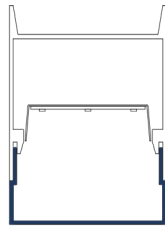

DD2 - 2" DROP

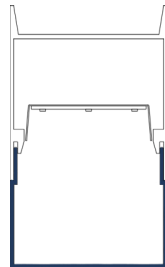

DASY - ASYMMETRIC

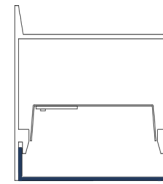

PATTERNS

Specify pattern shape and overall dimensions as shown below
 Patterns are connected with fully illuminated 12"x12" L, T, and X-shaped sections
 Please consult factory for custom patterns and shapes not shown below

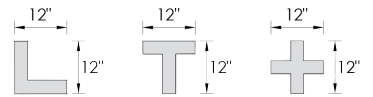

L-SHAPE	U-SHAPE	RECTANGLE/SQUARE	T-SHAPE	X-SHAPE
Provide dimensions of AxB Example: L - 6'x8'	Provide dimensions of AxBxC Example: U - 8'x10'x6"	Provide dimensions of AxB Example: R - 10'x8'	Provide dimensions of AxB Example: T - 14'x6'	Provide dimensions of AxB Example: X - 14'x14'

TYPICAL SECTION MOUNTING

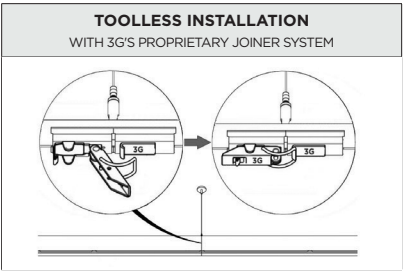
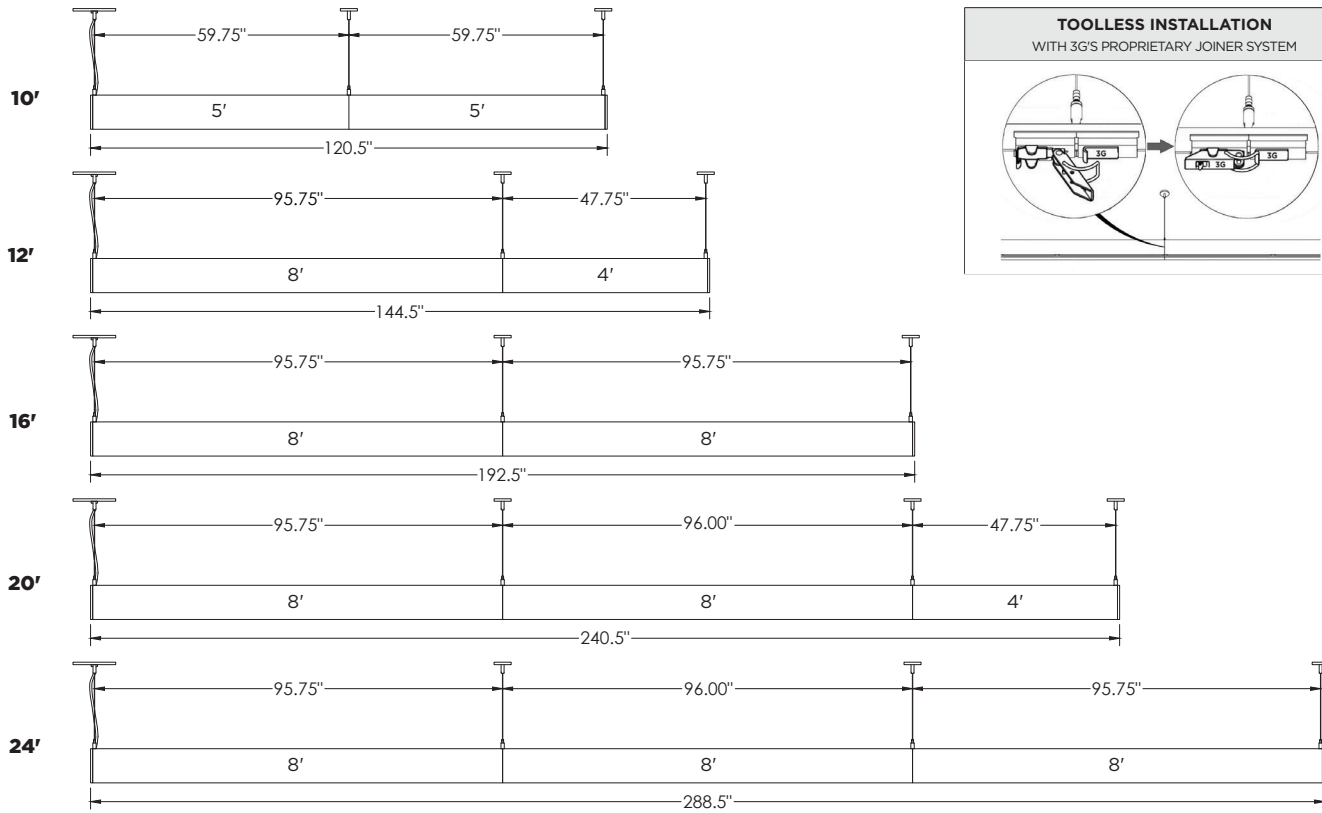

NOTE:
Run lengths and configurations not shown are available in 1" increments as standard

MOUNTING DETAILS

