

# 3G LIGHTING

## 3G-4RLI-WC

3.5" RECESSED LINEAR  
WALL TO CEILING



3.5" aperture with one piece extruded aluminum housing  
Seamless wall to ceiling illumination  
Proprietary alignment mechanism  
Suitable for drywall, wood, and grid ceiling applications  
Extruded acrylic lens available in flush, 1" and 2" drop lens options  
1% dimming standard with several driver options



<b>PROJECT:</b>		<b>TYPE:</b>	
<b>CATALOG#:</b>		<b>DATE:</b>	<b>QTY:</b>

CAT. NO	LUMEN OUTPUT	CRI	COLOR TEMP	VOLTAGE
<b>3G-4RLI-WC</b>	<b>D250</b> - 250 LM/FT <sup>1</sup> <b>D500</b> - 500 LM/FT <b>D750</b> - 750 LM/FT <b>D1000</b> - 1000 LM/FT <b>DC___</b> - CUSTOM OUTPUT (SPECIFY LM/FT) * <small>*Specify custom lumen outputs in 50lm increments (ie: DC600, DC650, DC700) Custom output cannot exceed D1000 DLC minimum lumen output is 500 lm/ft</small>	<b>S80</b> - 80+ CRI <sup>2</sup> <b>H90</b> - 90+ CRI <small>*DLC listing available with 80CRI</small>	<b>27K</b> - 2700K <b>30K</b> - 3000K <b>35K</b> - 3500K <b>40K</b> - 4000K <small>*DLC listing available with 35K</small>	<b>UNV</b> - 120/277V <b>347</b> - 347V <sup>3</sup>

DRIVER	FLANGE TYPE (WALL)	FLANGE TYPE (CEILING)	LENS OPTION
<b>DIM</b> - 0-10V (100-1%) <b>DO1</b> - 0-10V (100-0.1%) <b>DALI</b> - DALI (100-1%) <sup>4</sup> <b>DHL2</b> - LUTRON HI-LUME LDE1 (1% ECOSYSTEM) <b>DMX</b> - DMX (100-0%)	<b>WXTR</b> - TRIMLESS (MUD-IN DRYWALL) <b>WFX</b> - FLANGELESS	<b>CXTR</b> - TRIMLESS (MUD-IN DRYWALL) <b>CFX</b> - FLANGELESS <b>CGX</b> - GRID CEILING * (UNIVERSAL MOUNT) <small>*Universal mounting brackets used for all grid ceiling types only. See mounting section for details</small>	<b>FL</b> - FLUSH LENS <b>DD1</b> - 1" DROP LENS <sup>5</sup> <b>DD2</b> - 2" DROP LENS <sup>5</sup>

OPTIONS	RUN TYPE
<b>EMB</b> - EMERGENCY BATTERY * (INTEGRAL) <b>EMC</b> - EMERGENCY CIRCUIT <b>CP</b> - CHICAGO PLENUM <small>*Minimum 4' section</small>	<b>W</b> ___ ' X <b>C</b> ___ ' (WALL TO CEILING) * <b>W</b> ___ ' X <b>C</b> ___ ' X <b>W</b> ___ ' (WALL TO CEILING TO WALL) <small>*Available in 1" increments</small>

1 D250 (250LM/FT) not available in 2' length with DALI, DO1, DMX, or DHL2. Specify minimum DC350 for those driver options  
 2 S80 (80+ CRI) not available with 27K and 40K  
 3 347 available in "DIM" 0-10V only (100-1%)  
 4 DALI-2 (Type 6) provided as standard. Please consult factory for DALI (Type 8) options  
 5 DD1 (1" drop lens) and DD2 (2" drop lens) available with straight run type only



DLC listing starting at 500 lumens per foot (D500)  
Available with 80CRI and 3500K

BASED ON 4' LENGTH (80+ CRI AND 3500K SOURCE)

LENS OPTION	DELIVERED LUMENS (LM/FT)	SYSTEM WATTS (W/FT)	EFFICACY (LPW)
<b>FLUSH</b>	250	1.9	129
	500	3.9	129
	750	6.0	127
	1000	8.1	123
<b>1" DROP</b>	250	1.9	133
	525	3.9	134
	775	6.0	132
	1025	8.1	128
<b>2" DROP</b>	275	1.9	136
	525	3.9	136
	800	6.0	134
	1050	8.1	129

LUMEN OUTPUT MULTIPLIER: 27K=0.94, 30K=0.97, 35K=1.00, 40K=1.01, 90CRI=0.88

**FL - FLUSH LENS**

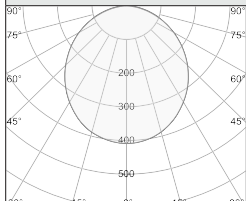

**3G-4RLI-D500-S80-FL**

DELIVERED LUMENS: 500 LM/FT (2000LM)  
 SYSTEM WATTS: 3.9 W/FT (15.6W)  
 EFFICACY: 129 LPW  
 CRI: 80+  
 CCT: 3500K  
 LENS OPTION: FLUSH

**DD1 - 1" DROP LENS**

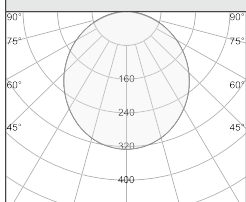

**3G-4RLI-D500-S80-DD1**

DELIVERED LUMENS: 525 LM/FT (2100LM)  
 SYSTEM WATTS: 3.9 W/FT (15.6W)  
 EFFICACY: 134 LPW  
 CRI: 80+  
 CCT: 3500K  
 LENS OPTION: 1" DROP

**DD2 - 2" DROP LENS**

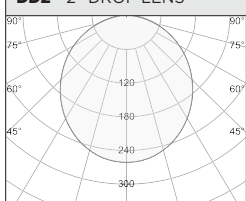

**3G-2RLI-D500-S80-DD2**

DELIVERED LUMENS: 525 LM/FT (2100LM)  
 SYSTEM WATTS: 3.9 W/FT (15.6W)  
 EFFICACY: 136 LPW  
 CRI: 80+  
 CCT: 3500K  
 LENS OPTION: 2" DROP

**HOUSING**

Extruded aluminum housing with 3.5" aperture  
 Individual units and continuous runs available in 1" increments as standard  
 Trimless model features a satin coat mudding flange for seamless ceiling integration  
 24-gauge LED reflector with high reflectance white powder coated finish  
 Standard polyester powder coated matte white finish

**OPTICS**

Extruded, satin acrylic lens designed for optimal performance and glare control. Up to 8' continuous

**LISTING**

ETL listed and conforms to UL1598 standard. Certified to CSA22.2 NO.250.0. Rated for indoor dry or damp locations  
 IC rated - Suitable for direct contact with insulation  
 DLC certified. Consult factory for details

**WARRANTY**

5 Year Warranty on LED and drivers  
 Manufacturer 1 Year Warranty for defects in material and workmanship under normal use  
 Ambient temperature at fixture should not exceed 25°C

**ELECTRICAL**

Standard 0-10V, constant current drivers with 100-1% dimming range and >0.9 power factor  
 Standard 120/277V universal voltage with several driver options  
 Luminaires are pre-wired with factory installed quick connects and branch circuit wiring  
 All drivers are integral and easily accessible through luminaire aperture  
 Minimum 4' and maximum 6' length for each integral emergency battery. 10W output for 90 minutes

**LED SYSTEM**

Proprietary LED system with color consistency <3 SDCM  
 Available in 27K, 30K, 35K, and 40K  
 Standard 80+CRI. Optional 90+CRI  
 R9 value of 56 for 90+CRI  
 L90 >60,000 hours  
 5 Year Warranty

**MOUNTING**

Housing suspended via 1/4" threaded rod or suspension cables (by others)  
 Toolless installation with 3G's proprietary mounting system  
 Internal, toolless joiner system (latch and hook) easily connects multiple sections together  
 LED reflectors remain within each fixture section during installation with 3G's click and lock spring system  
 Trimless fixture designed for use in drywall, mud-in ceiling applications  
 Flangeless fixture designed for use in wood ceilings. New construction only  
 Suitable for various grid ceiling applications (see mounting details)  
 Fixture weight: +/- 2.5 lb/ft

**HARD CEILING**

**CXTR - TRIMLESS CEILING**

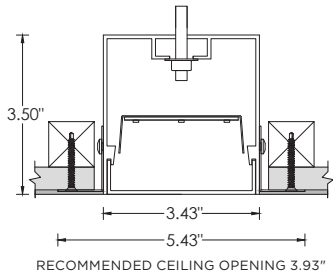

**WXTR - TRIMLESS WALL**

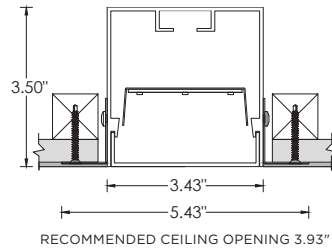

**CFX - FLANGELESS CEILING**

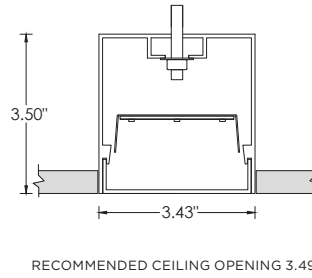

**WFX - FLANGELESS WALL**

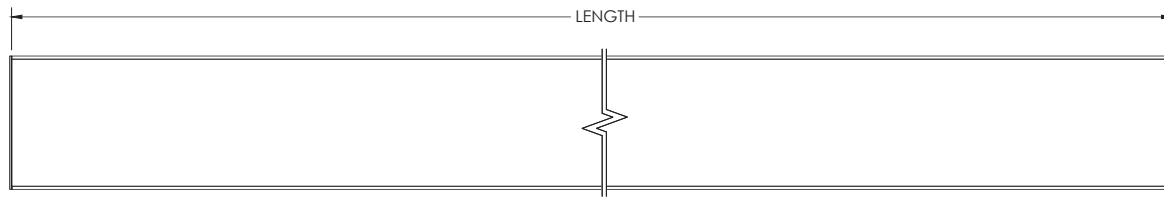
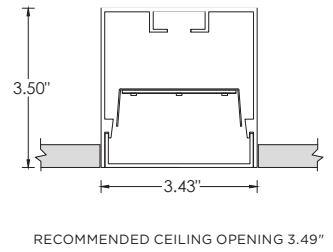

**LENS OPTION**

**FL - FLUSH**

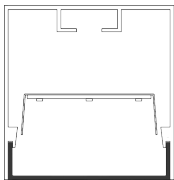

**DD1 - 1" DROP**

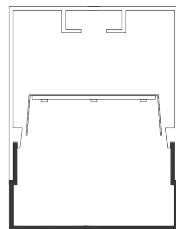

**DD2 - 2" DROP**

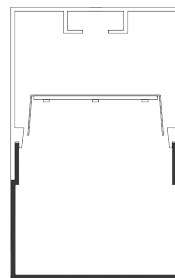

**HARD CEILING : MOUNTING DETAILS**

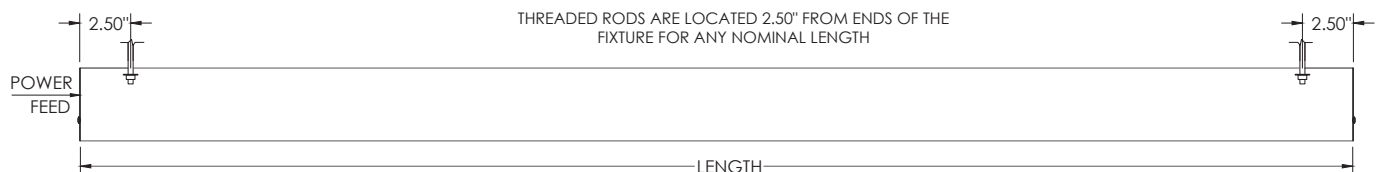
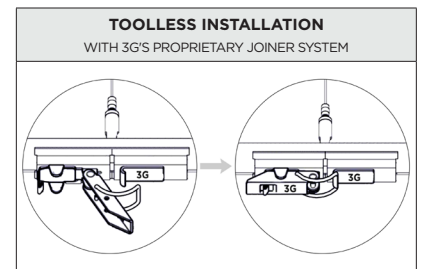

**GRID CEILING**

**9L - 9/16" LAYIN**

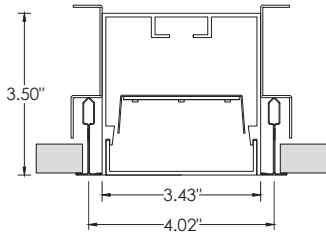

**9TG - 9/16" TEGULAR**

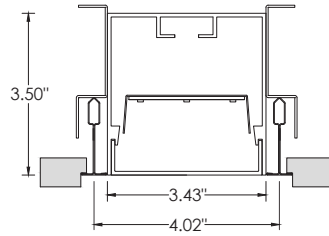

**15L - 15/16" LAYIN**

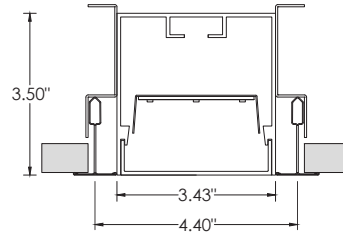

**15TG - 15/16" TEGULAR**

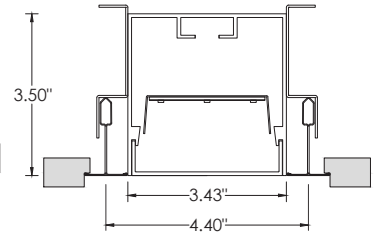

**9ST - 9/16" SLOT TEE TEGULAR**

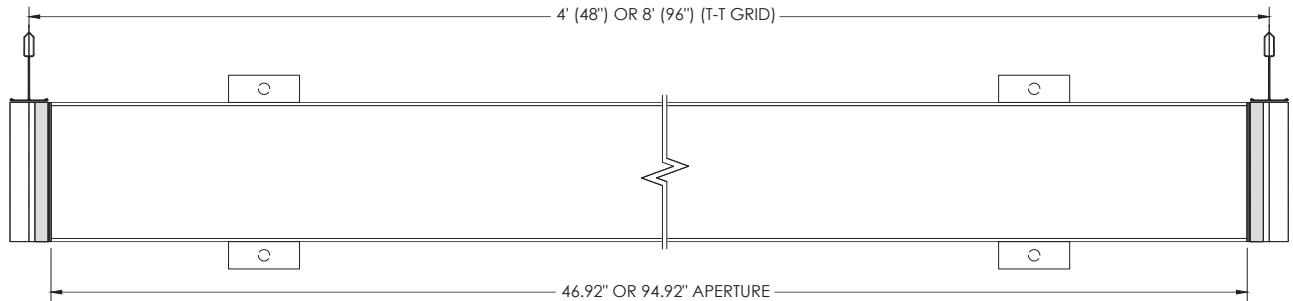
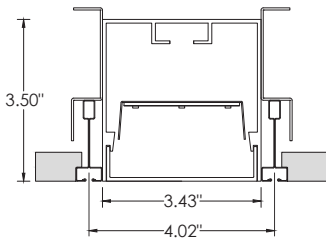

**GRID CEILING : MOUNTING DETAILS**

