

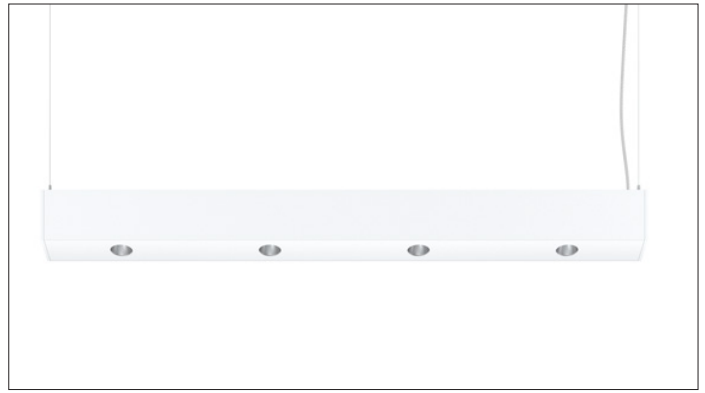

3G-4PDSL

3.5" LINEAR PENDANT
DOWNLIGHT SLOT



3.5" aperture with one piece extruded aluminum housing
Individual or continuous runs available in multiple run configurations
Extruded aluminum faceplate with fixed downlights
Standard downlight spacing options with custom spacing available
Optional indirect LED distribution

ORDERING INFORMATION

PROJECT:	<input type="text"/>	TYPE:	<input type="text"/>
CATALOG #:	<input type="text"/>	DATE:	<input type="text"/>

CAT. NO	LUMEN OUTPUT (DIRECT)	BEAM ANGLE (DL)	LUMEN OUTPUT (INDIRECT)	CRI (INDIRECT)
3G-4PDSL	10-S80 - 1000 LUMENS (80+ CRI)	20D - 20°	NI - NO INDIRECT	NI - NO INDIRECT S80 - 83+ CRI H90 - 93+ CRI
	15-S80 - 1500 LUMENS (80+ CRI)	40D - 40°	L250 - LOW OUTPUT (250LM/FT) ¹	
	22-S80 - 2200 LUMENS (80+ CRI)	60D - 60°	L500 - MEDIUM OUTPUT (500LM/FT)	
	10-H90 - 1000 LUMENS (90+ CRI)	90D - 90°	L750 - HIGH OUTPUT (750LM/FT)	
	15-H90 - 1500 LUMENS (90+ CRI)		L1000 - VERY HIGH OUTPUT (1000LM/FT) ²	
	22-H90 - 2200 LUMENS (80+ CRI)		LC___ - CUSTOM OUTPUT (SPECIFY LM/FT)	

*Specify custom lumen outputs in 50lm increments (ie: LC600, LC650, LC700)
Custom output cannot exceed LC1000

LENS OPTION (INDIRECT)	COLOR TEMP	VOLTAGE	DRIVER	HOUSING FINISH
NI - NO INDIRECT	27K - 2700K	UNV - 120/277V	DIM - 0-10V (STANDARD 100-1%)	BK - BLACK WH - WHITE SV - SILVER
FL - FLUSH LENS	30K - 3000K	120 - 120V (PHASE DIMMING)	LE - PHASE DIMMING ³ (TRIAC/ELV, 100-1%)	
WSO - WIDESPREAD OPTIC	35K - 3500K	347 - 347V (0-10 ONLY)	DHL2 - LUTRON HI-LUME LDE1 (1% ECOSYSTEM)	
ASY - ASYMMERTIC OPTIC	40K - 4000K		DALI - DALI (eIdoLED, 100-1%) ⁴ D01 - 0-10V (eIdoLED, 100-0.1%)	

CABLE LENGTH	CIRCUITING	RUN TYPE	DOWNLIGHT SPACING
60 - 60"	1C - 1 CIRCUIT 2C - 2 CIRCUIT	S - ___' (STRAIGHT RUN) [*]	12 - 12" ON CENTER
120 - 120"		L - ___'X ___' (L-SHAPE)	18 - 18" ON CENTER
		U - ___'X ___' X ___' (U-SHAPE)	24 - 24" ON CENTER
		R - ___'X ___' (RECTANGLE/SQUARE)	36 - 36" ON CENTER
			48 - 48" ON CENTER
			CUS (xx) - CUSTOM SPACING *

*Specify number of fixture heads (XX)

1 L250 (250LM/FT) not available for indirect in 2' and 3' lengths (Please specify LC400 for 2' and 3' fixture length when outputs lower than 500LM/FT are required)
2 L1000 (1000LM/FT) not available for indirect for H90 (93+ CRI) or ASY (Indirect Asymmetric optic)
3 Phase dimming options available in 120V only
4 DALI-2 (Type 6) provided as standard. Please consult factory for DALI (Type 8) options

MAY 11, 2023



**3G-4PDSL**

LIGHTING 3.5" LINEAR PENDANT DOWNLIGHT SLOT

PERFORMANCE CHART DIRECT BASED ON 60° BEAM ANGLE AND 3500K SOURCE

LUMEN OUTPUT	80+ CRI			90+ CRI			97+ CRI		
	DELIVERED LUMENS	SYSTEM WATTS	EFFICACY (LPW)	DELIVERED LUMENS	SYSTEM WATTS	EFFICACY (LPW)	DELIVERED LUMENS	SYSTEM WATTS	EFFICACY (LPW)
1000LMs	1015	10.2	100	893	10.2	88	833	10.0	82
1500LMs	1400	13.9	101	1232	13.9	89	1148	13.9	83
2200LMs	2194	22.0	100	1931	22.0	88	1799	22.0	82

LUMEN OUTPUT ADJUSTMENT FACTORS	CCT	Multiplier
	2700K	0.94
	3000K	0.97
	3500K	1.00
	4000K	1.01

PERFORMANCE CHART INDIRECT BASED ON 4' LENGTH (83+ CRI AND 3500K SOURCE)

LENS OPTION	DELIVERED LUMENS (PER FT)			SYSTEM WATTS (PER FT)			EFFICACY (LPW)		
	DIRECT	INDIRECT	TOTAL	DIRECT	INDIRECT	TOTAL	DIRECT	INDIRECT	TOTAL
60° DOWNLIGHT + FLUSH	1015	250	1265	10.2	1.7	11.9	100	150	106
	1400	500	1900	13.9	3.4	17.3	101	153	110
	2194	750	2944	22.0	5.0	27	100	150	109
	2194	1000	3194	22.0	7.0	29	100	144	110
60° DOWNLIGHT + WSO	1015	250	1265	10.2	1.7	11.9	100	143	106
	1400	500	1900	13.9	3.4	17.3	101	143	110
	2194	750	2944	22.0	5.0	27	100	141	109
	2194	1000	3194	22.0	7.0	29	100	137	110
60° DOWNLIGHT + ASYMMETRIC	1015	250	1265	10.2	3.4	13.6	100	74	93
	1400	500	1900	13.9	6.5	20.4	101	78	93
	2194	750	2944	22.0	10.1	32.1	100	73	92

LUMEN OUTPUT ADJUSTMENT FACTORS	CCT	Multiplier
	2700K	0.94
	3000K	0.97
	3500K	1.00

EFFICACY (LPW) ADJUSTMENT FACTOR	CRI	Multiplier
	93+	0.88

PHOTOMETRY (DIRECT)

20D - 20° BEAM ANGLE

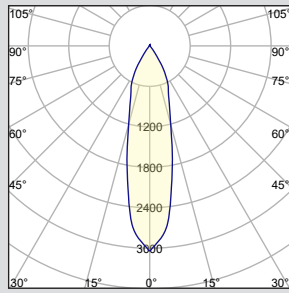

3G-4PDSL-15-S80-35K-20D

LUMEN OUTPUT: 1500 LMs
 DELIVERED LUMENS: 1122LMs
 SYSTEM WATTS: 13.9W
 EFFICACY: 79LPW
 CRI: 80+
 CCT: 3500K

60D - 60° BEAM ANGLE

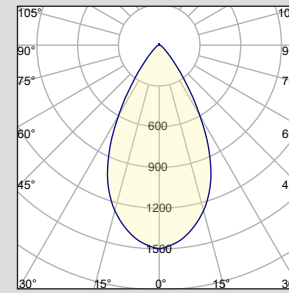

3G-4PDSL-15-S80-35K-60D

LUMEN OUTPUT: 1500 LMs
 DELIVERED LUMENS: 1400LMs
 SYSTEM WATTS: 13.9W
 EFFICACY: 101LPW
 CRI: 80+
 CCT: 3500K

40D - 40° BEAM ANGLE

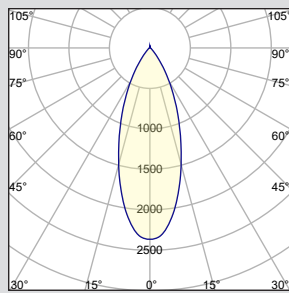

3G-4PDSL-15-S80-35K-40D

LUMEN OUTPUT: 1500 LMs
 DELIVERED LUMENS: 1343LMs
 SYSTEM WATTS: 13.9W
 EFFICACY: 97LPW
 CRI: 80+
 CCT: 3500K

90D - 90° BEAM ANGLE

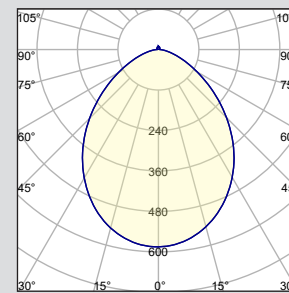

3G-4PDSL-15-S80-35K-90D

LUMEN OUTPUT: 1500 LMs
 DELIVERED LUMENS: 1323LMs
 SYSTEM WATTS: 13.9W
 EFFICACY: 93LPW
 CRI: 80+
 CCT: 3500K

PHOTOMETRY (INDIRECT)

FL - FLUSH

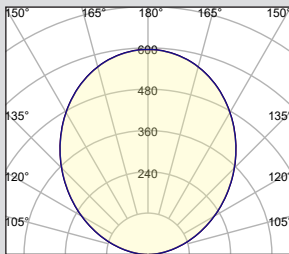

3G-4PDSL-L500-S80-35K-FL

DELIVERED LUMENS: 500LM/FT (2000LM)
 SYSTEM WATTS: 3.4W/FT (13.6W)
 EFFICACY: 153LPW
 CRI: 83+
 CCT: 3500K
 LENS OPTION: FLUSH

ASY - ASYMMETRIC OPTIC

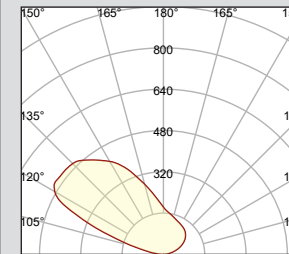

3G-4PDSL-L500-S80-35K-ASY

DELIVERED LUMENS: 500LM/FT (2000LM)
 SYSTEM WATTS: 6.5W/FT (26.0W)
 EFFICACY: 78LPW
 CRI: 83+
 CCT: 3500K
 LENS OPTION: ASYMMETRIC

WSO - WIDESPREAD OPTIC

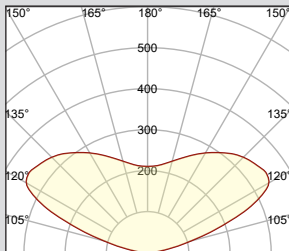

3G-4PDSL-L500-S80-35K-WSO

DELIVERED LUMENS: 500LM/FT (2000LM)
 SYSTEM WATTS: 3.4/FT (13.6W)
 EFFICACY: 143LPW
 CRI: 83+
 CCT: 3500K
 LENS OPTION: WIDESPREAD

TECHNICAL**HOUSING**

- 3.5" extruded aluminum housing with machined aluminum end caps
- Extruded aluminum faceplate with fixed downlights
- Standard on center downlight spacing options with custom spacing available
- Flush extruded acrylic lens for optional indirect LED source
- Individual units and continuous runs available in 1' increments
- Standard 12"x12" mitered corners provided for various run configurations

ELECTRICAL

- Standard 0-10V, constant current drivers with 100-1% dimming range and >0.9 power factor
- Standard 120/277V universal voltage drivers. Optional 347V, 0-10V drivers
- 120V Forward Phase/Reverse Phase driver option with 100-1% dimming range
- eldoLED 0-10V driver option available with 100-0.01% dimming range
- eldoLED DALI and Lutron EcoSystem driver options available with 100-1% dimming range
- All drivers are integral and easily accessible through fixture aperture

LED SYSTEM**DOWNLIGHT**

- Citizen LED module (field replaceable)
- Color consistency <2 SDCM
- Standard (80+CRI). Optional (90+ and 97+CRI)
- Available in 27K, 30K, 35K, and 40K
- L90 >50,000 hours
- 5 Year Warranty

INDIRECT LINEAR

- Proprietary LED system with color consistency <3 SDCM
- Available in 27K, 30K, 35K, and 40K
- Standard (83+CRI). Optional (93+CRI)
- R9 >60,000 hours
- 5 Year Warranty

MOUNTING

- Proprietary toolless mechanism for joining sections in continuous runs
- Suitable for drywall and wood ceilings (see mounting details)
- Suitable for various grid ceiling applications (see mounting details)
- All mounting canopies provided in white finish as standard

LISTING

- ETL listed and conforms to UL1598 standard. Certified to CSA22.2 NO.250.0. Rated for indoor dry or damp locations

WARRANTY

- 5 Year Warranty on LED and drivers
- Manufacturer 1 Year Warranty for defects in material and workmanship under normal use
- Ambient temperature at fixture should not exceed 25°C

DRAWINGS AND DIMENSIONS

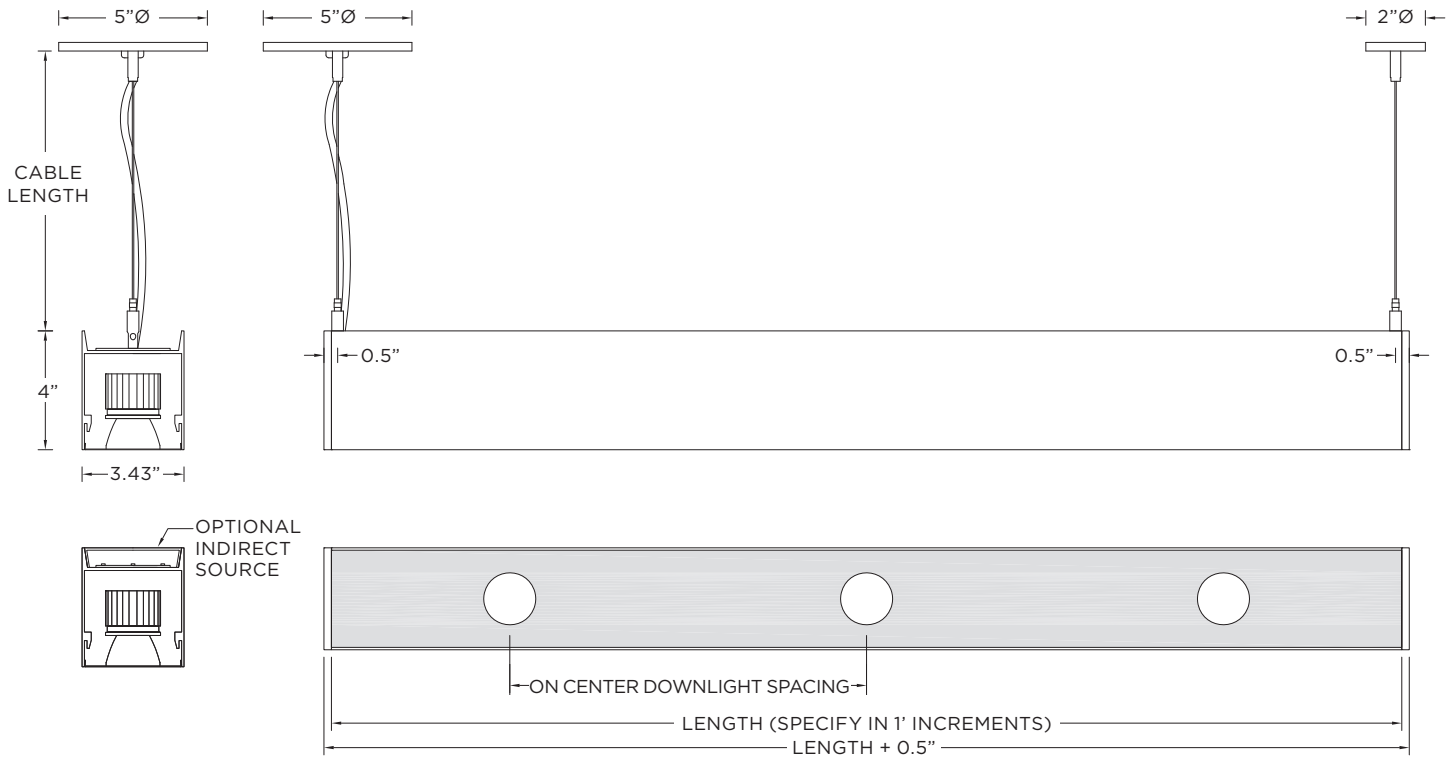

PATTERNS

Specify pattern shape and overall dimensions as shown below
 Patterns are connected with fully illuminated 12"x12" L and X-shaped sections
 Please consult factory for custom patterns and shapes not shown below

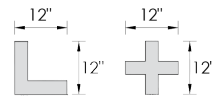

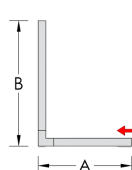
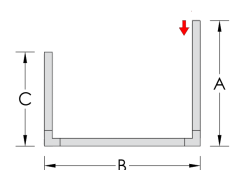
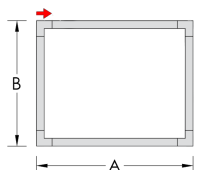
L-SHAPE	U-SHAPE	RECTANGLE/SQUARE
Provide dimensions of AxB Example: L - 6'x8'	Provide dimensions of AxBxC Example: U - 8'x10'x6'	Provide dimensions of AxB Example: R - 10'x8'
		

3G

3G-4PDSL

LIGHTING 3.5" LINEAR PENDANT DOWNLIGHT SLOT

TYPICAL SECTION MOUNTING (AVAILABLE IN 1' INCREMENTS AS STANDARD)

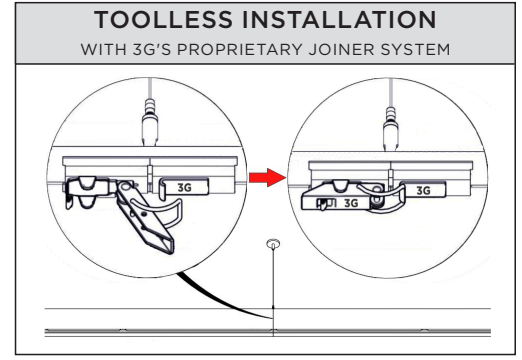
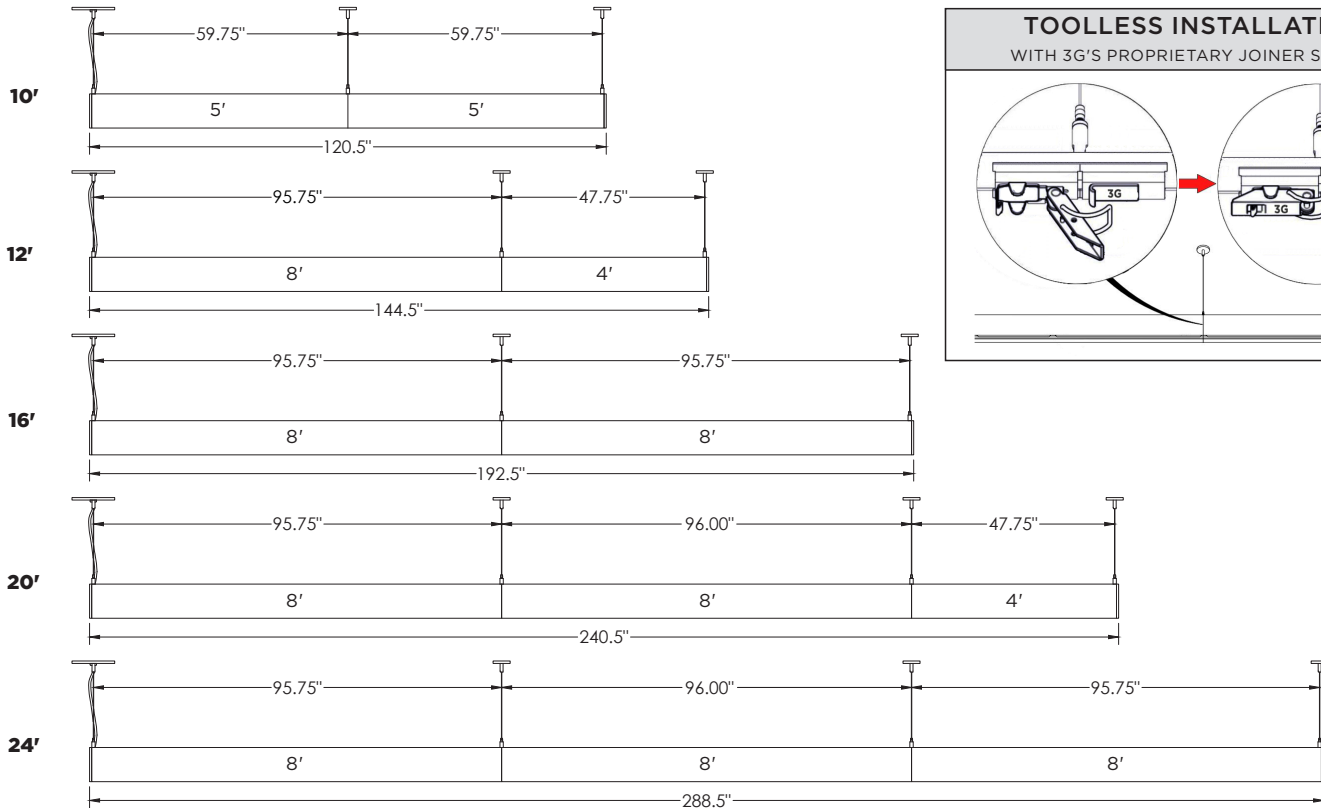

MOUNTING DETAILS

