

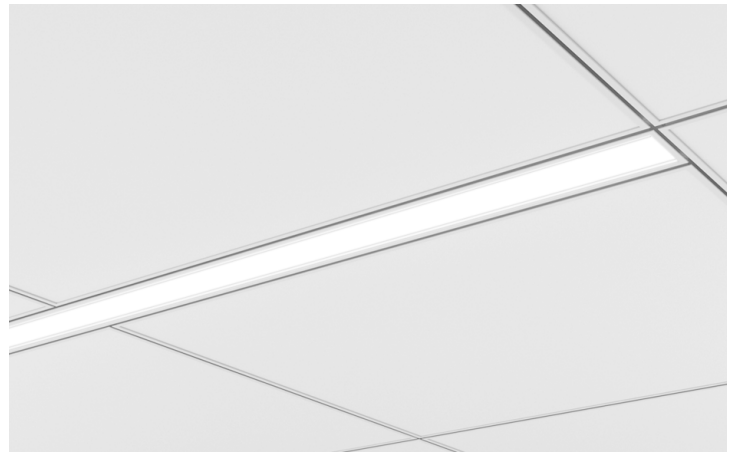

3G-2RLI
2" RECESSED LINEAR
GRID CEILING

Narrow 2" aperture with one piece extruded aluminum housing
Individual or continuous runs available in multiple run configurations
Suitable for drywall, wood, and various grid ceilings
Extruded acrylic lens available in flush, 1" and 2" drop lens options
All drop lens options feature illuminated end caps
1% dimming standard with several driver options



ORDERING INFORMATION

PROJECT:	<input type="text"/>	TYPE:	<input type="text"/>
CATALOG #:	<input type="text"/>	DATE:	<input type="text"/>

CAT. NO	LUMEN OUTPUT	CRI	COLOR TEMP	VOLTAGE	DRIVER
3G-2RLI	L250 - LOW OUTPUT (250 LM/FT) ¹	S80 - 83+ CRI (STANDARD)	27K - 2700K	UNV - 120/277V	DIM - 0-10V (STANDARD 100-1%) DHL2 - LUTRON HI-LUME LDE (100-1% ECOSYSTEM) DALI - DALI (100-1%) DO1 - 0-10V (100-0.1%)
	L500 - MEDIUM OUTPUT (500 LM/FT)		30K - 3000K		
	L750 - HIGH OUTPUT (750 LM/FT)	H90 - 93+ CRI	35K - 3500K		
	L1000 - VERY HIGH OUTPUT (1000 LM/FT) ²		40K - 4000K		
	LC ____ - CUSTOM OUTPUT (SPECIFY LM/FT)				

FLANGE TYPE	LENS OPTION	OPTIONS	LENGTH (FEET)
GC1 - 9/16 LAYIN	FL - FLUSH DD1 - 1" DROP LENS DD2 - 2" DROP LENS DASY - ASYMMETRIC OPTIC	EMC - EMERGENCY CIRCUIT CP - CHICAGO PLENUM	* Individual units available in 2' through 8' 2' fixtures not available for grid ceiling applications Continuous runs available in 1' increments
GC1S - 9/16 TEGULAR			
GC1P - 9/16 TEGULAR			
GC2 - 15/16 LAYIN			
GC2S - 15/16 TEGULAR			
GC2P - 15/16 TEGULAR			
GC3 - 9/16 SLOT TEE TEGULAR			

¹ L250 (250LM/FT) not available in 2' and 3' lengths
(Please specify LC400 for 2' and 3' fixture length when outputs lower than 500LM/FT are required)
² L1000 (1000LM/FT) not available for H90 (93+ CRI)



3G-2RLI

LIGHTING 2" RECESSED LINEAR - GRID CEILING

PERFORMANCE CHART Based on 4' length (83+ CRI and 3500K)

LENS OPTION	DELIVERED LUMENS (PER FOOT)	SYSTEM WATTS	EFFICACY (LM/W)
FLUSH	250	2.0	124
	500	4.7	109
	750	7.5	100
	1000	10.4	97
1" DROP LENS	250	2.0	127
	525	4.7	111
	750	7.4	101
	1000	10.4	96
2" DROP LENS	275	2.0	134
	550	4.7	116
	775	7.4	105
	1025	10.4	99
ASYMMETRIC	250	2.0	124
	500	4.1	120
	750	6.3	120
	1000	8.8	115

LUMEN OUTPUT ADJUSTMENT FACTORS	CCT	Multiplier
	2700K	0.94
	3000K	0.97
	3500K	1.00
4000K	1.01	

EFFICACY (LPW) ADJUSTMENT FACTOR	CRI	Multiplier
	93+	0.88



3G-2RLI

LIGHTING 2" RECESSED LINEAR - GRID CEILING

TECHNICAL

HOUSING

- Extruded aluminum housing with narrow 2" aperture
- Individual units and continuous runs available in 1' increments
- 24 gauge LED reflector with high reflectance white powder coated finish
- Extruded acrylic lens with a satin finish designed for optimal performance and glare control
- Lens options available in flush, 1" drop and 2" drop
- Standard polyester powder coated matte white finish

ELECTRICAL

- Standard 0-10V, 100-1% dimming and 0.9 power factor
- Standard 120/277V universal voltage drivers. Optional 347V 0-10V driver
- Lutron EcoSystem and eldoLED Dali options available with 100-1% dimming
- All drivers are integral and easily accessible through the aperture
- Integral Emergency Battery: 90 minutes

LED SYSTEM

- Proprietary LED system
- Color consistency < 3 SDCM
- Standard (83+CRI). Optional (93+CRI)
- Available in 27K, 30K, 35K, and 40K
- Average rated life of > 50,000 hours
- 5-year warranty

MOUNTING

- Housing suspended via 1/4" threaded rod or suspension cables
- Suitable for various grid ceilings applications (see mounting details)

LISTING

- ETL listed and tested to UL standards. Suitable for dry and damp locations

WARRANTY

- 5 Year warranty on LED and drivers
- Manufacturer 1-year warranty for defects in material and workmanship under normal use
- Ambient temperature at fixture should not exceed 25°C

DRAWINGS AND DIMENSIONS (GRID CEILING)

GC1 - 9/16" LAYIN

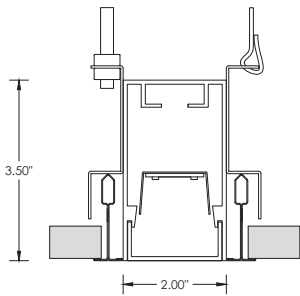

GC3 - 9/16" SLOT TEE TEGULAR

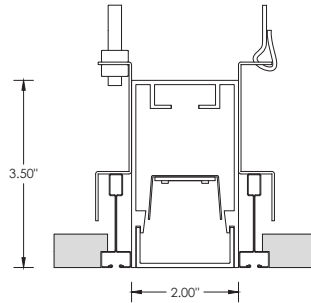

LENS OPTION

FL - FLUSH LENS

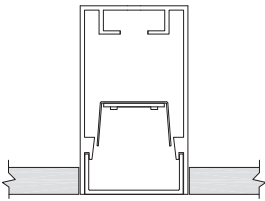

DD1 - 1" DROP LENS

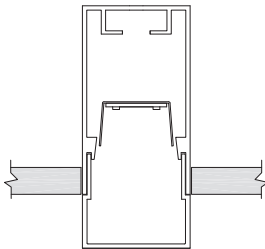

DD2 - 2" DROP LENS

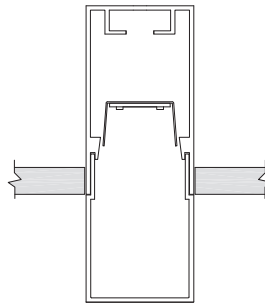

DASY - ASYMMETRIC OPTIC

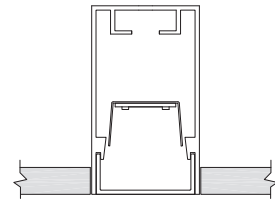

MOUNTING

GC1 - 9/16" LAYIN

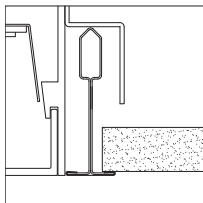

GC1S - 9/16" TEGULAR

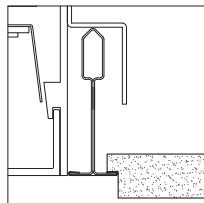

GC1P - 9/16" TEGULAR

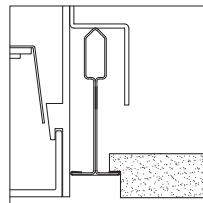

GC2 - 15/16" LAYIN

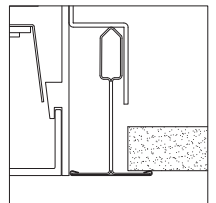

GC2S - 15/16" TEGULAR

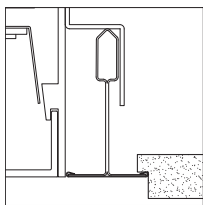

GC2P - 15/16" TEGULAR

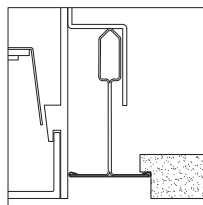

GC3 - 9/16" SLOT TEE TEGULAR

