

3G LIGHTING

3G-4RPE

3.5" RECESSED PERIMETER
TUNABLE WHITE & RGBW

Narrow 3.5" aperture with one piece extruded aluminum housing
Designed for continuous runs in 1' increments as standard
12" fully illuminated end filler option is field cuttable for odd lengths
LED system with performance up to 147 lumens per watt
Lens position available in flush, 1", 2" and 3" regressed options
Asymmetric optics available for room side performance
1% dimming standard with several integral driver options

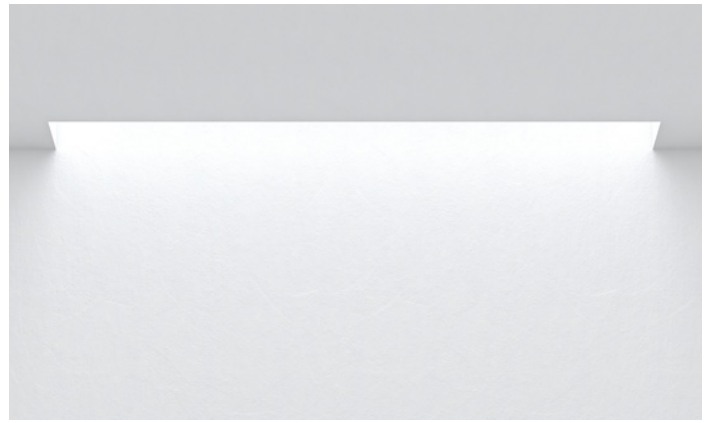

3GT **3GB**

ORDERING INFORMATION

PROJECT:	<input type="text"/>	TYPE:	<input type="text"/>
CATALOG #:	<input type="text"/>	DATE:	<input type="text"/>

CAT. NO	LED SOURCE	LUMEN OUTPUT	CRI	VOLTAGE
3G-4RPE	TW - TUNABLE WHITE (2700K-6500K) RGBW - INFINITE COLOR ¹ (3500K WHITE)	L250 - LOW OUTPUT (250 LM/FT) ² L500 - MEDIUM OUTPUT (500 LM/FT) L750 - HIGH OUTPUT (750 LM/FT) L1000 - VERY HIGH OUTPUT (1000 LM/FT) ³ LC___ - CUSTOM OUTPUT (SPECIFY LM/FT) * <small>*Specify custom lumen outputs in 50lm increments (ie: LC600, LC650, LC700) Custom output cannot exceed LC1000 Lumen outputs suitable for white LED source only</small>	S80 - 83+ CRI H90 - 93+ CRI ¹	UNV - 120/277V

DRIVER	FLANGE TYPE	LENS POSITION	OPTIONS
D01 - 0-10V (STANDARD 100-0.1%) DALI - DALI (eidoLED, 100-1%) DMX - DMX (eidoLED, 100-0%) ¹ DHLT - LUTRON T SERIES (100-1%) (2 CHANNEL TUNABLE WHITE)	WT - WHITE TRIM XTR - TRIMLESS FX - FLANGELESS GCX - GRID CEILING (UNIVERSAL MOUNT)* <small>*Grid ceiling fixtures ship with universal mounting brackets suitable for all ceiling types. See mounting section for details</small>	FL - FLUSH DASY - ASYMMETRIC OPTIC ¹ RG1 - 1" REGRESSED RG2 - 2" REGRESSED RG3 - 3" REGRESSED	EF - END FILLER* EMC - EMERGENCY CIRCUIT ⁴ CP - CHICAGO PLENUM <small>*12" fully illuminated end filler option is field cuttable for odd lengths</small>

RUN TYPE
S - ___' (STRAIGHT RUN) L - ___' X ___' (L-SHAPE) U - ___' X ___' X ___' (U-SHAPE) <small>*Individual units available from 2' to 8' Continuous runs available in 1' increments as standard Use end filler option for odd lengths (tunable white only)</small>

¹ RGBW LED source available with S80 (83+CRI) and DMX driver option only. Not available with asymmetric optic or EM options
² L250 (250LM/FT) not available in 2' and 3' lengths. Specify LC400 for 2' and 3' fixture lengths when outputs lower than 500LM/FT are required
³ L1000 (1000LM/FT) not available for H90 (93+ CRI)
⁴ EMC (emergency circuit) option available for tunable white LED source only. Not available with RGBW

3GT - Tunable White
3GB - RGBW

SEPTEMBER 28, 2021

PERFORMANCE CHART BASED ON 4' LENGTH WITH FLUSH LENS (TUNABLE WHITE AND 83+ CRI)

COLOR TEMP	DELIVERED LUMENS (LM/F)	SYSTEM WATTS (W/FT)	EFFICACY (LPW)
2700K	250	1.9	126
	500	3.8	121
	750	5.8	119
	1000	8.0	118
3500K	250	1.9	126
	500	3.8	121
	750	5.8	119
	1000	8.0	118
6500K	250	1.9	147
	500	3.8	145
	750	5.8	138
	1000	8.0	132

EFFICACY (LPW) ADJUSTMENT FACTOR	CRI	Multiplier
	93+	0.88

PHOTOMETRY PERFORMANCE CHARTS BASED ON A 4' FIXTURE WITH MEDIUM LUMEN OUTPUT OPTION (L500)

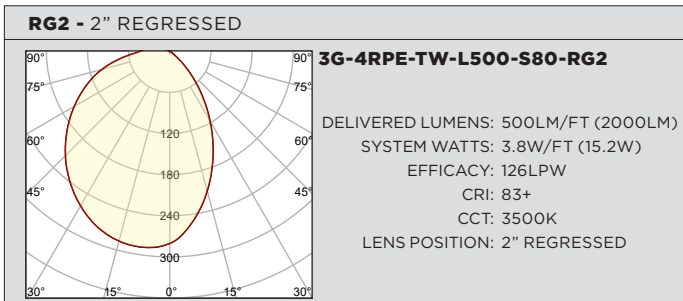
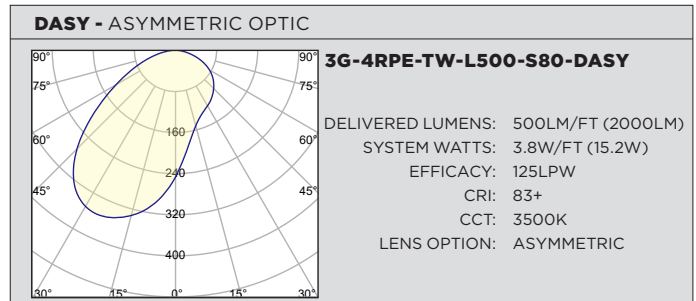
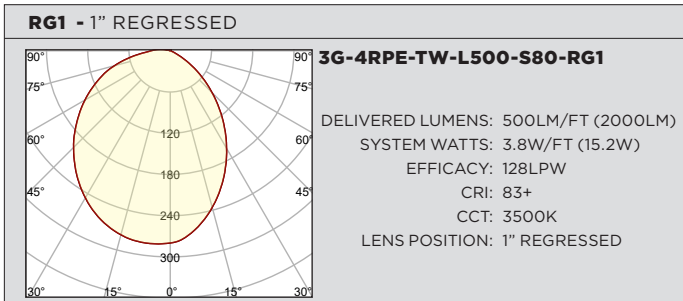
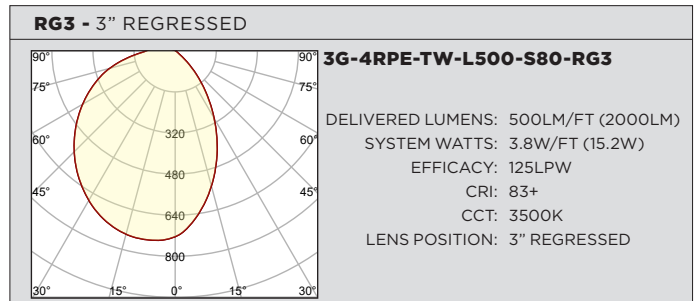
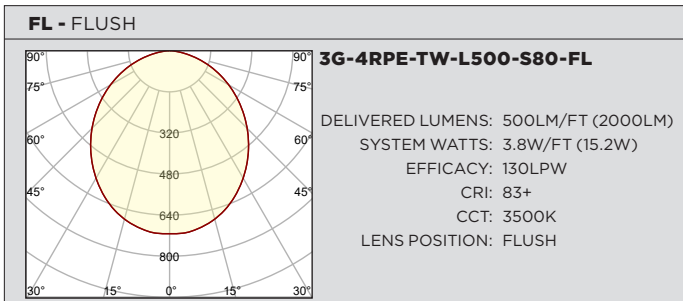

PERFORMANCE CHART BASED ON 4' LENGTH (RGBW WITH 83+ CRI AND 3500K SOURCE)

COLOR TEMP	DELIVERED LUMENS (LM/F)	SYSTEM WATTS (W/FT)	EFFICACY (LPW)
3500K	250	2.2	119
	500	4.6	113
	750	7.8	96
	1000	11.3	89
LUMINOUS INTENSITY PER LED	RGB	INTENSITY Min - Max (mcd)	
	RED	355 - 805	
	GREEN	710 - 1400	
	BLUE	140 - 355	

PHOTOMETRY PERFORMANCE CHARTS BASED ON A 4' FIXTURE WITH MEDIUM LUMEN OUTPUT OPTION (L500)

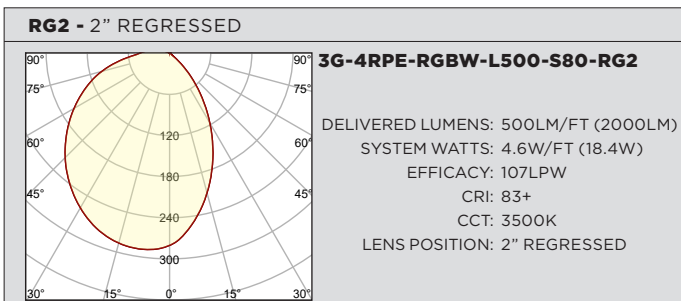
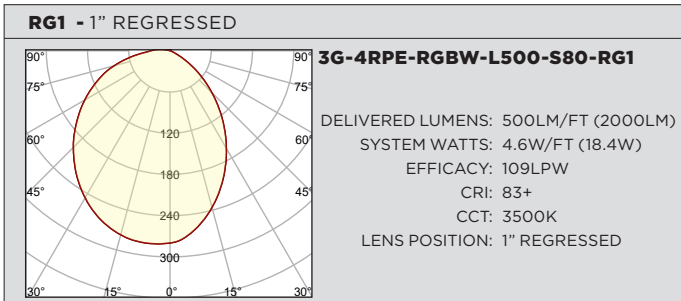
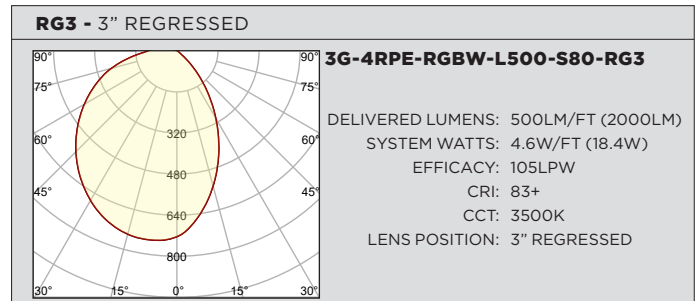
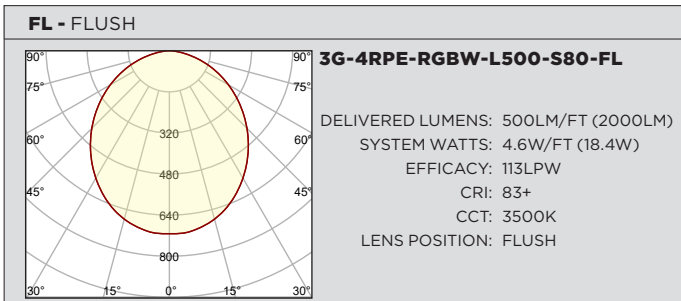

TECHNICAL**HOUSING**

Extruded aluminum housing with narrow 3.5" aperture
Individual units and continuous runs available in 1' increments
12" fully illuminated end filler option is field cuttable for odd lengths
Trim flange with matte white powder coated finish and minimal 0.400" overlap
Trimless model features a satin coat mudding flange for seamless ceiling
24-gauge LED reflector with high reflectance white powder coated finish
Standard polyester powder coated matte white finish

OPTICS

Extruded, satin acrylic lens designed for optimal performance and glare control. Up to 8' continuous
Lens position available in flush, 1", 2", and 3" regressed options
High performance asymmetric optics available

ELECTRICAL

Luminaires are pre-wired with factory installed quick connects and branch circuit wiring
Multiple driver options available for tunable white LED system
DMX driver option for RGBW system with RDM control and 100-0% dimming range
All drivers are integral and easily accessible through luminaire aperture

LED SYSTEM FOR TUNABLE WHITE (TW)

Proprietary LED system with color consistency <3 SDCM
2700K-6500K CCT range
Standard 83+CRI. Optional 93+CRI. (R9 value of 56 for 93+CRI)
L90 >60,000 hours
5 Year Warranty

LED SYSTEM FOR RGBW

Proprietary LED system with color consistency <3 SDCM
White LED available in 35K with 83+ CRI
L80 >72,000 hours
Red (335-805 mcd)
Green (710-1400 mcd)
Blue (140-355 mcd)
5 Year Warranty

MOUNTING

New construction housing suspended via 1/4" threaded rod or suspension cables (by others)
Trim fixture designed for use in drywall, wood, and other architectural ceilings
Trimless fixture designed for use in drywall, mud-in ceiling applications
Flangeless fixture designed for use in wood ceilings
Suitable for various grid ceiling applications (see mounting details)
Standard mounting available in flush and regressed options up to 3". Consult 3G for modifications
Fixture weight: +/- 3 lbs/ft

LISTING

ETL listed and tested to cUL standards. Suitable for dry and damp locations

WARRANTY

5 Year Warranty on LED and drivers
Manufacturer 1 Year Warranty for defects in material and workmanship under normal use
Ambient temperature at fixture should not exceed 25°C

DRAWINGS AND DIMENSIONS

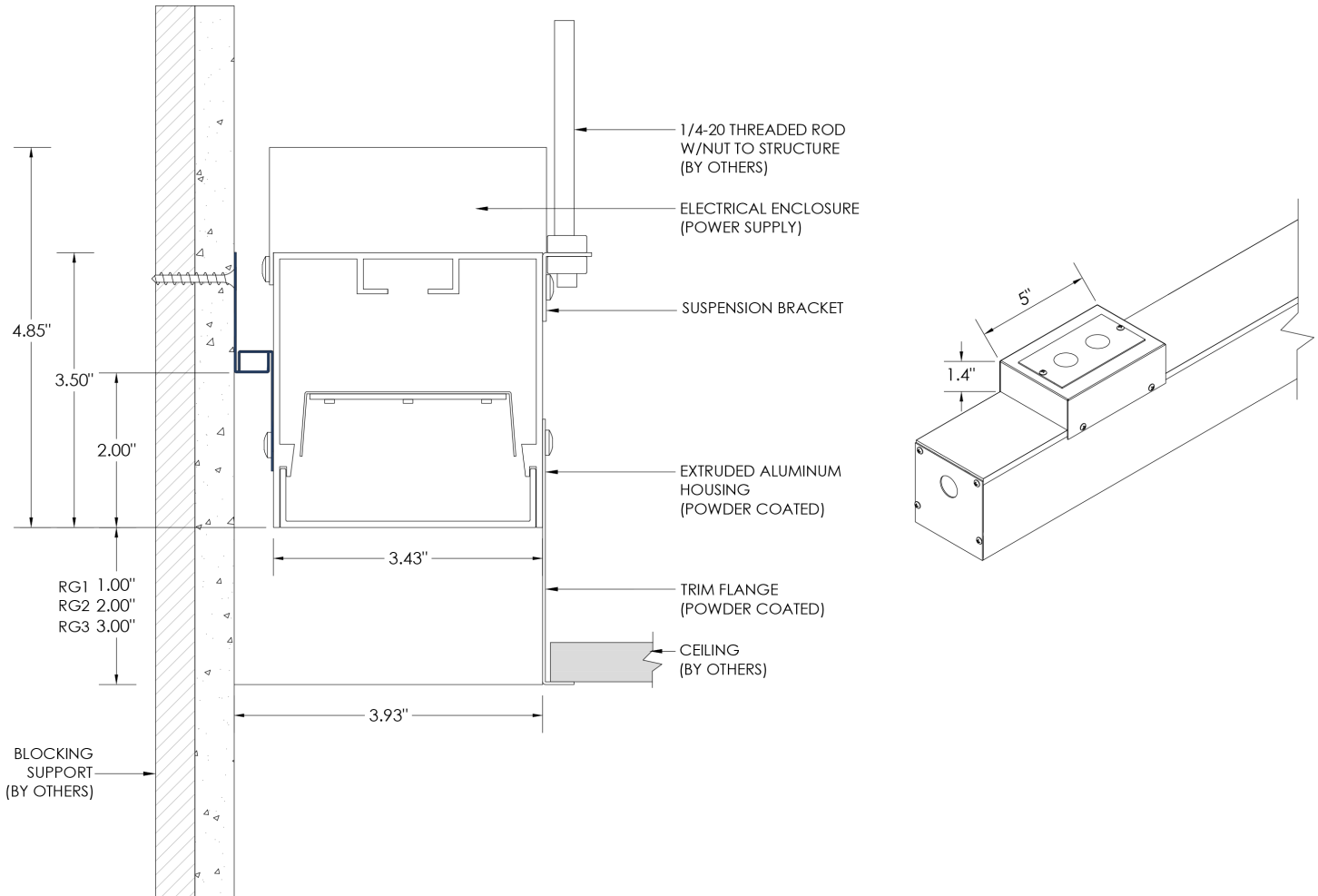

LENS POSITION

FL - FLUSH

RG1 - 1" REGRESSED

RG2 - 2" REGRESSED

RG3 - 3" REGRESSED

DASY - ASYMMETRIC OPTIC (ROOM SIDE)

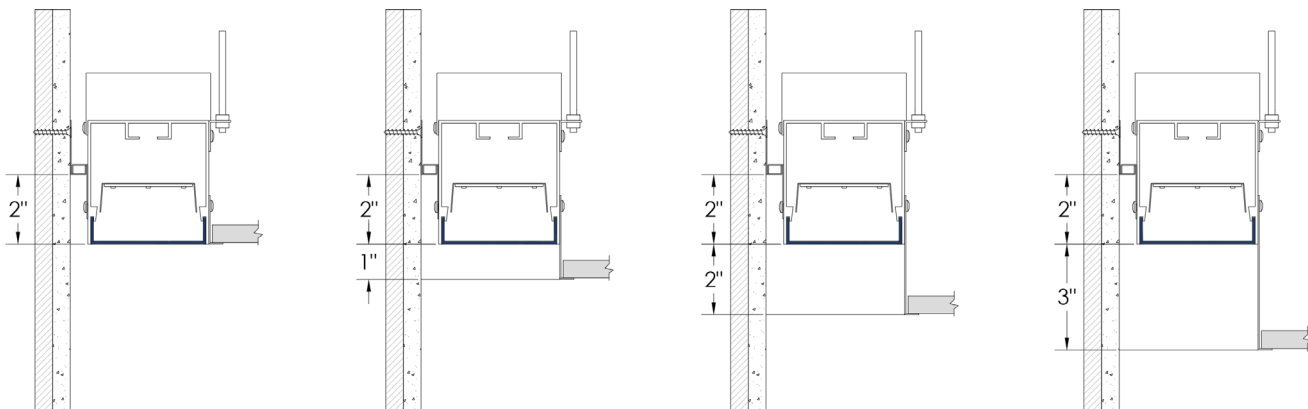

HARD CEILING MOUNTING TYPES

FLUSH

WT - TRIM

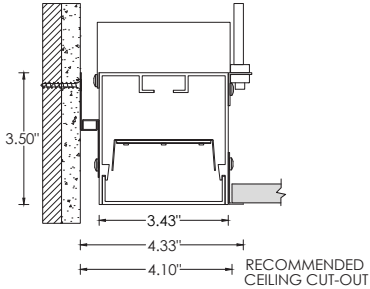

XTR - TRIMLESS

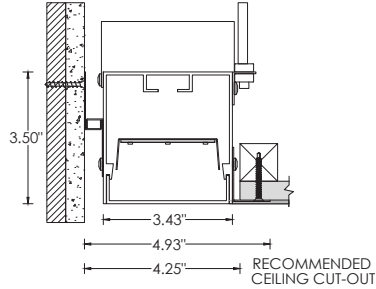

FX - FLANGELESS

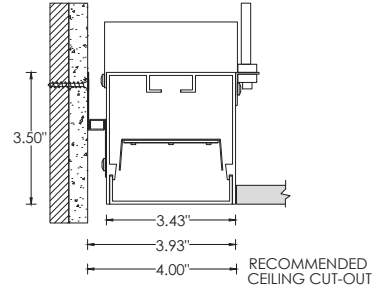

2" REGRESSED

WT - TRIM

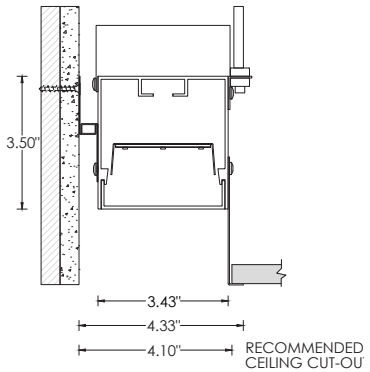

XTR - TRIMLESS

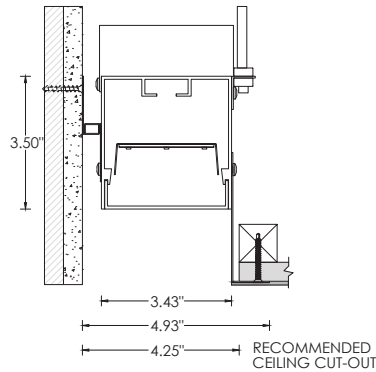

FX - FLANGELESS

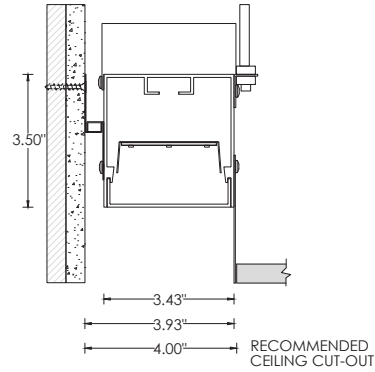

GRID CEILING MOUNTING TYPES

FLUSH

9L - 9/16" LAYIN

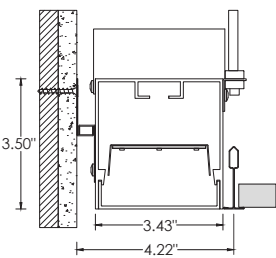

9TG - 9/16" TEGULAR

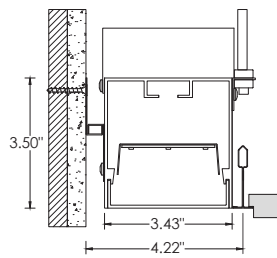

15L - 15/16" LAYIN

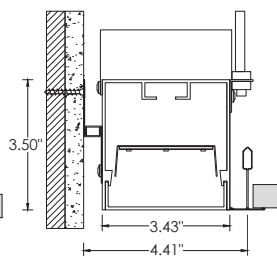

15TG - 15/16" TEGULAR

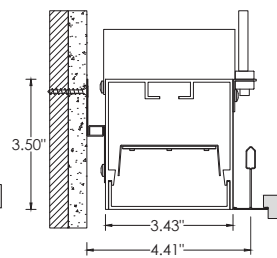

9ST - 9/16" SLOT TEE TEGULAR

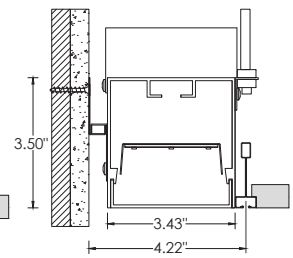

2" REGRESSED

9L - 9/16" LAYIN

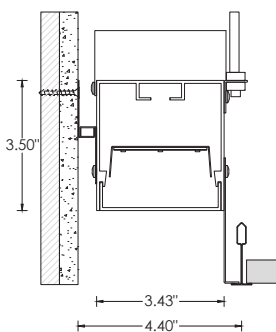

9TG - 9/16" TEGULAR

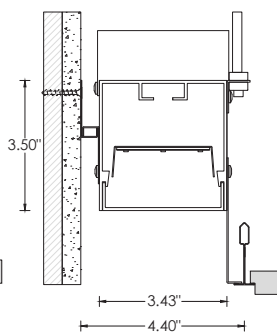

15L - 15/16" LAYIN

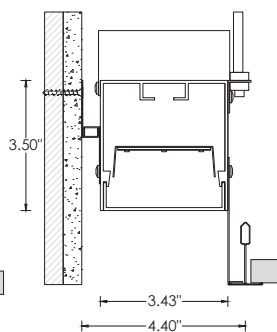

15TG - 15/16" TEGULAR

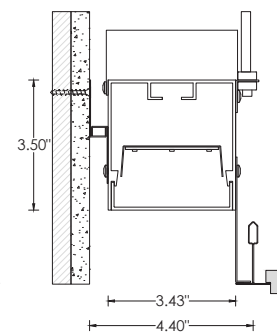

9ST - 9/16" SLOT TEE TEGULAR

