

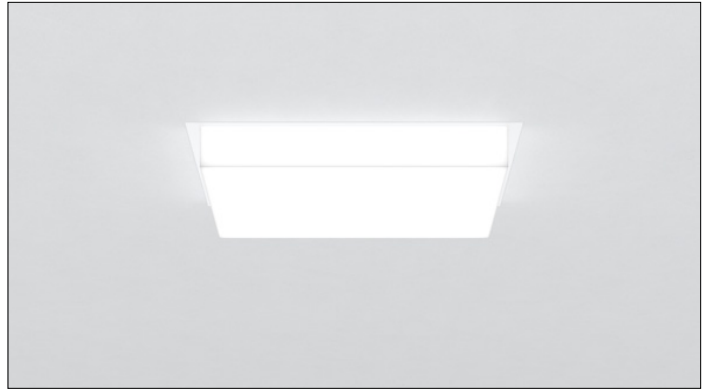

# 3G-RKU24

24" RECESSED KUBO



Features a white sandblasted acrylic diffuser with mitered corners  
 Proprietary LED source fully saturates the hand fabricated acrylic  
 Multiple drop lens options in 1" increments (flush through 3" drop)  
 Drop lenses feature evenly illuminated sides with distinctive lines  
 Suitable for drywall, wood, and various grid ceiling applications  
 1% dimming standard with several driver options

<b>PROJECT:</b>		<b>TYPE:</b>	
<b>CATALOG#:</b>		<b>DATE:</b>	<b>QTY:</b>

CAT. NO	LUMEN OUTPUT	CRI	COLOR TEMP	VOLTAGE
<b>3G-RKU24</b>	<b>L15</b> - 1500 LUMENS <b>L30</b> - 3000 LUMENS <b>L45</b> - 4500 LUMENS <b>L60</b> - 6000 LUMENS	<b>S80</b> - 80+ CRI	<b>27K</b> - 2700K <b>30K</b> - 3000K <b>35K</b> - 3500K <b>40K</b> - 4000K	<b>UNV</b> - 120/277V <b>347</b> - 347V <sup>1</sup>

DRIVER	FLANGE TYPE	LENS OPTION	OPTIONS
<b>DIM</b> - 0-10V (100-1%) <b>DO1</b> - 0-10V (100-0.1%) <b>DALI</b> - DALI (100-1%) <sup>2</sup> <b>DHL2</b> - LUTRON HI-LUME (1% ECOSYSTEM)	<b>GCX</b> - GRID CEILING (UNIVERSAL MOUNT) <b>DFK</b> - DRYWALL FRAME KIT	<b>FL</b> - FLUSH LENS <b>DD1</b> - 1" DROP LENS <b>DD2</b> - 2" DROP LENS <b>DD3</b> - 3" DROP LENS <b>DD4</b> - 4" DROP LENS <b>DD5</b> - 5" DROP LENS <b>DD6</b> - 6" DROP LENS <b>DD7</b> - 7" DROP LENS	<b>CP</b> - CHICAGO PLENUM <b>EMB</b> - EMERGENCY BATTERY (INTEGRAL) <b>EMC</b> - EMERGENCY CIRCUIT

<sup>1</sup> 347 available in "DIM" 0-10V only (100-1%)

<sup>2</sup> DALI-2 (Type 6) provided as standard. Please consult factory for DALI (Type 8) options

BASED ON 80+ CRI AND 3500K SOURCE

LENS OPTION	DELIVERED LUMENS	SYSTEM WATTS	EFFICACY (LPW)
<b>FLUSH</b>	1500	12.0	121
	3000	25.1	116
	4500	40.2	110
	6000	58.4	102
<b>1" DROP</b>	1500	12.0	121
	3000	25.1	117
	4500	40.2	111
	6000	58.4	102
<b>2" DROP</b>	1500	12.0	122
	3000	25.1	118
	4500	40.2	112
	6000	58.4	103
<b>3" DROP</b>	1500	12.0	123
	3000	25.1	119
	4500	40.2	112
	6000	58.4	104
<b>4" DROP</b>	1500	12.0	124
	3000	25.1	119
	4500	40.2	113
	6000	58.4	104
<b>5" DROP</b>	1500	12.0	127
	3000	25.1	123
	4500	40.2	117
	6000	58.4	108
<b>6" DROP</b>	1500	12.0	128
	3000	25.1	124
	4500	40.2	117
	6000	58.4	109
<b>7" DROP</b>	1500	12.0	130
	3000	25.1	126
	4500	40.2	119
	6000	58.4	110

LUMEN OUTPUT MULTIPLIER: 27K=0.94, 30K=0.97, 35K=1.00, 40K=1.01

**FL - FLUSH LENS**

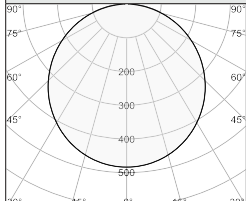

**3G-RKU24-15-S80-35K-FL**

LUMEN OUTPUT: 1500 LM  
 DELIVERED LUMENS: 1446 LM  
 SYSTEM WATTS: 12.0 W  
 EFFICACY: 121 LPW  
 CRI: 80+  
 CCT: 3500K  
 LENS OPTION: FLUSH

**DD2 - 2" DROP LENS**

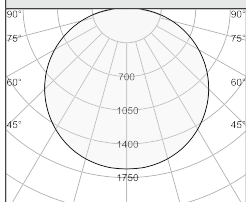

**3G-RKU24-15-S80-35K-DD2**

LUMEN OUTPUT: 1500 LM  
 DELIVERED LUMENS: 1465 LM  
 SYSTEM WATTS: 12.0 W  
 EFFICACY: 122 LPW  
 CRI: 80+  
 CCT: 3500K  
 LENS OPTION: 2" DROP

**DD4 - 4" DROP LENS**

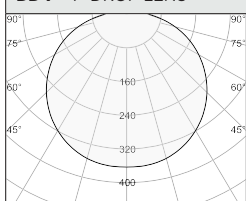

**3G-RKU24-15-S80-35K-DD4**

LUMEN OUTPUT: 1500 LM  
 DELIVERED LUMENS: 1482 LM  
 SYSTEM WATTS: 12.0 W  
 EFFICACY: 124 LPW  
 CRI: 80+  
 CCT: 3500K  
 LENS OPTION: 4" DROP

**DD6 - 6" DROP LENS**

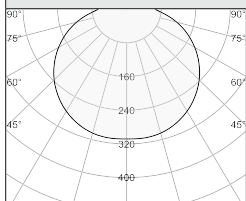

**3G-RKU24-15-S80-35K-DD6**

LUMEN OUTPUT: 1500 LM  
 DELIVERED LUMENS: 1541 LM  
 SYSTEM WATTS: 12.0 W  
 EFFICACY: 128 LPW  
 CRI: 80+  
 CCT: 3500K  
 LENS OPTION: 6" DROP

**HOUSING**

White, fabricated sandblasted acrylic diffuser with distinctive lines  
 Multiple drop lens options in 1" increments (flush through 7" drop)  
 Housing constructed in 20 gauge cold rolled steel  
 Standard matte white powder coated finish  
 24 gauge LED reflector with high reflectance white powder coated finish

**LISTING**

ETL listed and conforms to UL1598 standard. Certified to CSA22.2 NO.250.0. Rated for indoor dry or damp locations

**WARRANTY**

5 Year Warranty on LED and drivers  
 Manufacturer 1 Year Warranty for defects in material and workmanship under normal use  
 Ambient temperature at fixture should not exceed 25°C

**ELECTRICAL**

Luminaires are pre-wired with factory installed quick connects and branch circuit wiring  
 Standard 0-10V, constant current drivers with 100-1% dimming range and >0.9 power factor  
 Standard 120/277V universal voltage drivers. Optional 347V, 0-10V drivers  
 Lutron EcoSystem and eldoLED DALI options available with 100-1% dimming range  
 All drivers are integral and easily accessible through luminaire aperture  
 Integral emergency battery. 10W output for 90 minutes

**LED SYSTEM**

Proprietary LED system with color consistency <3 SDCM  
 Available in 27K, 30K, 35K, and 40K  
 Standard 80+CRI  
 L90 >60,000 hours  
 5 Year Warranty

**MOUNTING**

Suitable for various grid ceiling applications (see mounting details)  
 Drywall frame kit available

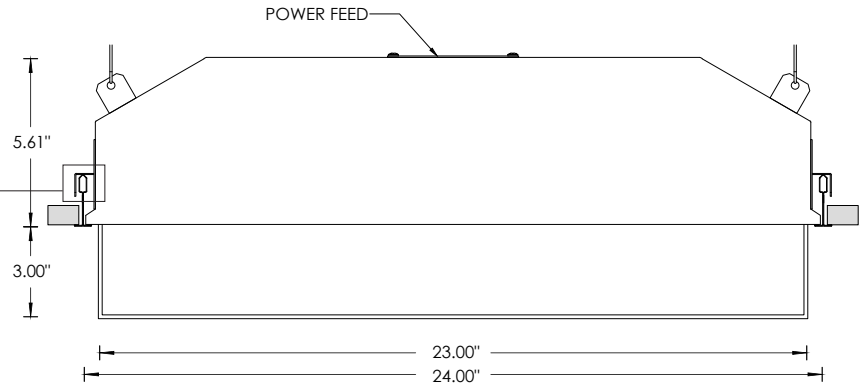
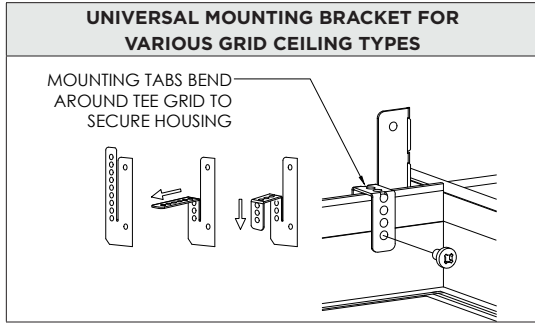

**LENS OPTION**

**FL - FLUSH**



**DD1 - 1" DROP LENS**



**DD2 - 2" DROP LENS**



**DD3 - 3" DROP LENS**

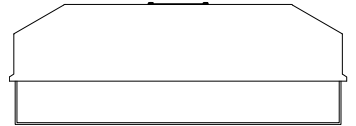

**DD4 - 4" DROP LENS**

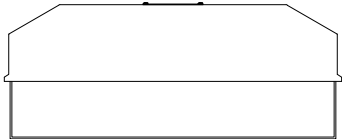

**DD5 - 5" DROP LENS**

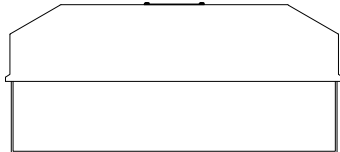

**DD6 - 6" DROP LENS**

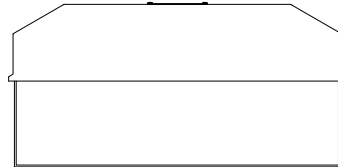

**DD7 - 7" DROP LENS**

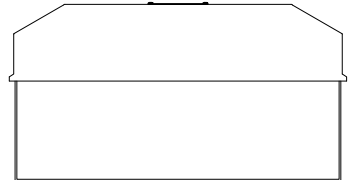

**MOUNTING**

**9L - 9/16" TEGULAR**

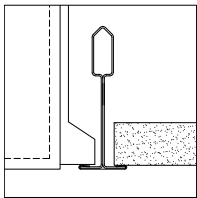

**9TG - 9/16" TEGULAR**

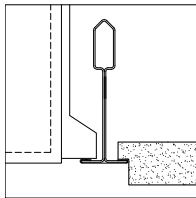

**15L - 15/6" DROP LENS**

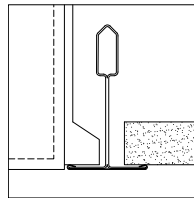

**15TG - 15/6" TEGULAR**

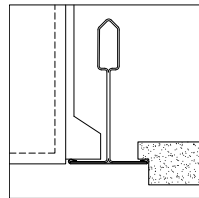

**9ST - 9/16" SLOT TEE TEGULAR**

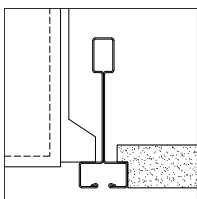

**DFK - DRYWALL FRAME KIT**

