

3G LIGHTING

3G-SDL45RF

4.5" DOWNLIGHT CYLINDER
7" AND 11" HEIGHT
DYNAMIC WHITE

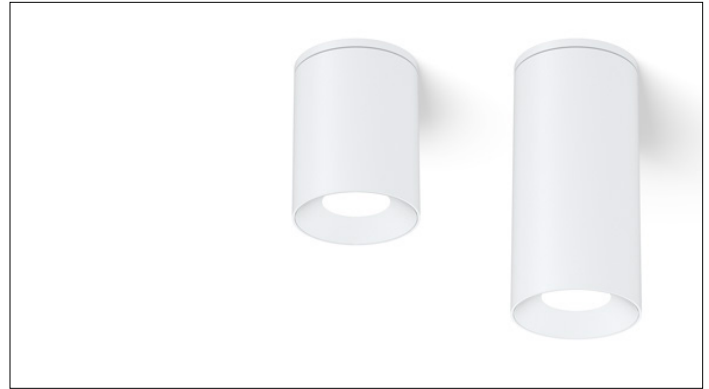

4.5" diameter high performance cylinders
Companion to 3G-DL45R series downlight family
Extruded aluminum housing with powder coated finish
Twist and lock construction and no visible hardware
Regressed LED source for enhanced glare control
Dim to Warm and Tunable White LED options up to 2000lm (90+CRI)
1% dimming standard with several integral driver options

3GD 3GT

PROJECT:		TYPE:	
CATALOG#:		DATE:	QTY:

CAT. NO	FIXTURE HEIGHT	LED SOURCE	LUMEN OUTPUT	CRI	BEAM ANGLE
3G-SDL45RF	7H - 7" HEIGHT * 11H - 11" HEIGHT	DW - DIM TO WARM (1800-3000K) TW - TUNABLE WHITE ¹ (2700-6500K)	08 - 800 LUMENS 12 - 1200 LUMENS 20 - 2000 LUMENS	H90 - 90+ CRI	10D - 10° ² 20D - 20° 40D - 40° 60D - 60° 90D - 90° *
	<small>*7H available in Dim to Warm only. Maximum 1200lm output (DIM and LE only)</small>				<small>*90D reflector supplied standard with lens</small>

VOLTAGE	DRIVER	HOUSING FINISH	INSERT FINISH
UNV - 120/277V 120 - 120V	DIM - 0-10V (100-1%) LE - PHASE DIM ³ (TRIAC/ELV, 100-1%) D01 - 0-10V (100-0.1%) ¹ DALI - DALI (100-1%) ^{1,4} DHL2 - LUTRON HI-LUME (1% ECOSYSTEM) DMX - DMX (100-0%) ¹	WH - WHITE BK - BLACK SV - SILVER CF - CUSTOM RAL COLOR	WI - WHITE BI - BLACK SI - SILVER CI - CUSTOM RAL COLOR

OPTIONS
LS - LINEAR SPREAD LENS SB - SANDBLASTED LENS SF - SOFTENING LENS (SUPPLIED STANDARD) CFW - WHITE CONDUIT FEED CANOPY CFB - BLACK CONDUIT FEED CANOPY CFS - SILVER CONDUIT FEED CANOPY EMR - EMERGENCY BATTERY (REMOTE) ⁵
<small>Maximum 1 optical accessory only Not available with 90D reflector option</small>

- ¹ Tunable White option not available in 7" height. 11" model available with D01, DALI and DMX driver options only
- ² 10D reflector available with 800lm option only
- ³ Phase dimming options available in 120V only
- ⁴ DALI-2 (Type 6) provided as standard. Consult factory for DALI Type 8 option
- ⁵ Fixture operates at 6500K in emergency mode. Emergency battery installed remotely by others. Not accessible through the inside of the fixture

3GD - Warm Dim
3GT - Tunable White

BASED ON 20° BEAM ANGLE AND 3500K SOURCE

LUMEN OUTPUT	90+ CRI		
	DELIVERED LUMENS	SYSTEM WATTS	EFFICACY (LPW)
800LMs	N/A	N/A	N/A
1200LMs	1200	15.4	78
2000LMs	1689	23.2	73

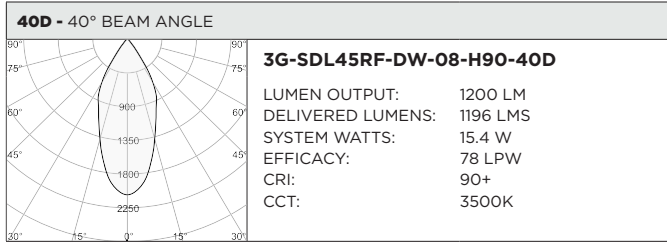
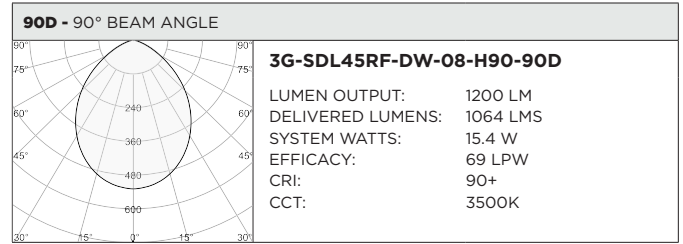
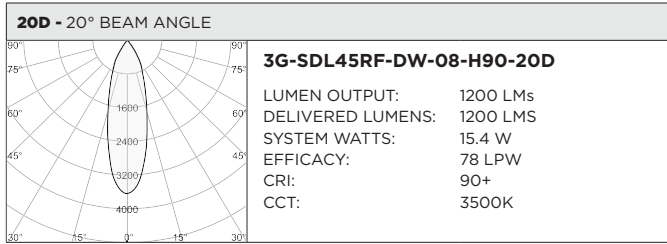
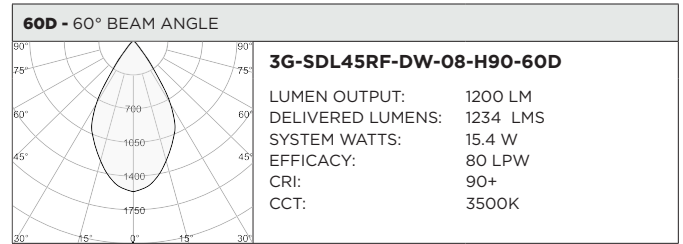
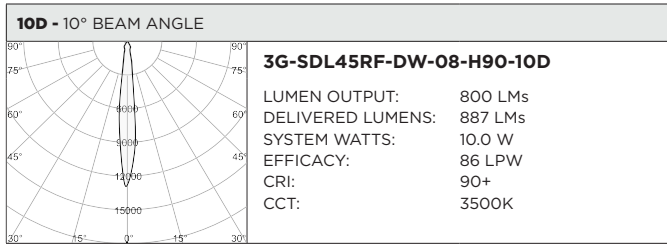

BASED ON 20° BEAM ANGLE

LUMEN OUTPUT	90+ CRI (2700K)			90+ CRI (3500K)			90+ CRI (6500K)		
	DELIVERED LUMENS	SYSTEM WATTS	EFFICACY (LPW)	DELIVERED LUMENS	SYSTEM WATTS	EFFICACY (LPW)	DELIVERED LUMENS	SYSTEM WATTS	EFFICACY (LPW)
800LMs	N/A	N/A	N/A	N/A	N/A	N/A	N/A	N/A	N/A
1200LMs	1143	16.6	69	1180	16.6	71	1284	16.6	77
2000LMs	1622	24.5	66	1694	24.5	69	1807	24.5	74

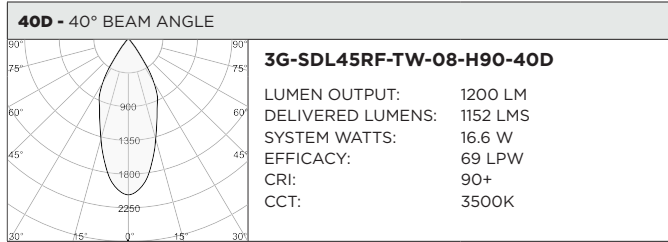
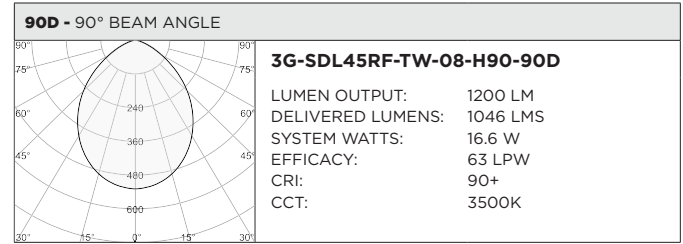
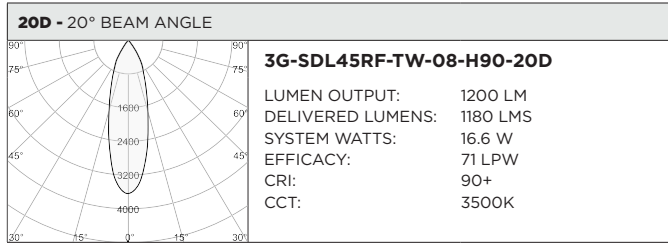
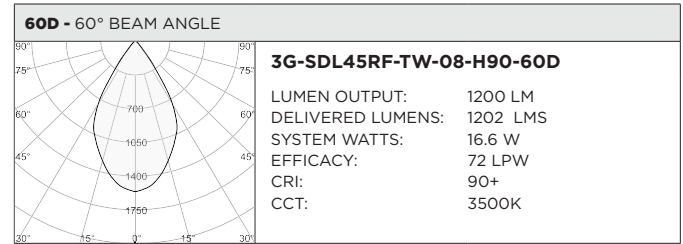
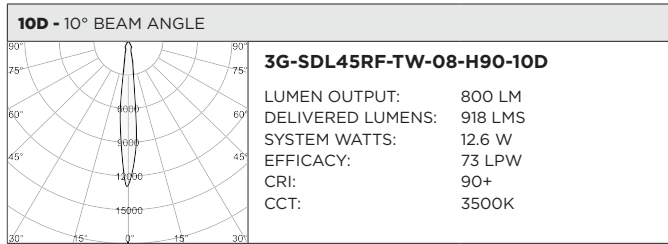

HOUSING

Extruded aluminum housing with powder coated finish
Twist and lock construction with no visible hardware

BEVELED INSERT

4.5" aperture with regressed LED source for enhanced glare control
Cast aluminum insert with matte powder coated finish

OPTICS

Proprietary anodized, aluminum reflectors are field replaceable (10° reflector not interchangeable)
Available in 10°, 20°, 40°, 60° and 90°

MOUNTING

All hardware included for mounting to 4" octagonal junction box
Conduit feed cut-out canopy option designed to mount to 4" octagonal junction box
Twist and lock mechanism

WARRANTY

5 Year Warranty on LED and drivers
Manufacturer 1 Year Warranty for defects in material and workmanship under normal use
Ambient temperature at fixture should not exceed 25°C

ELECTRICAL

Standard 0-10V, constant current drivers with 100-1% dimming range and >0.9 power factor
Standard 120/277V universal voltage drivers.
120V Forward Phase/Reverse Phase driver option with 100-1% dimming range
eldoLED 0-10V driver option available with 100-0.01% dimming range
eldoLED DALI and Lutron EcoSystem driver options available with 100-1% dimming range
DMX driver option available with 100-0% dimming range
All drivers are integral and easily accessible through fixture aperture

LED SYSTEM

Bridgelux LED module (field replaceable)
Color consistency <3 SDCM
Standard 90+ CRI
Dim to Warm (1800K-3000K)
Tunable White (2700K-6500K)
L70 >50,000 hours
5 Year Warranty

LISTING

ETL listed and conforms to UL1598 standard. Certified to CSA22.2 No.250.0.
Rated for indoor dry or damp locations

RECESSED 4" OCTAGONAL JUNCTION BOX BY OTHERS
STANDARD CANOPY MOUNT

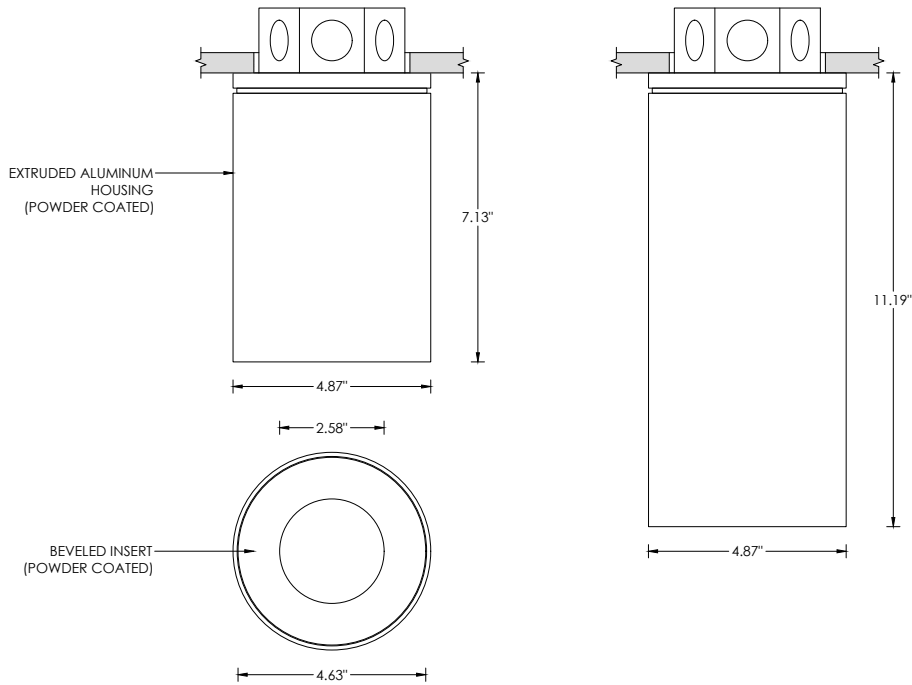

SURFACE 4" OCTAGONAL X 1.5" DEEP JUNCTION BOX BY OTHERS
CONDUIT FEED CANOPY MOUNT (CFX OPTION)

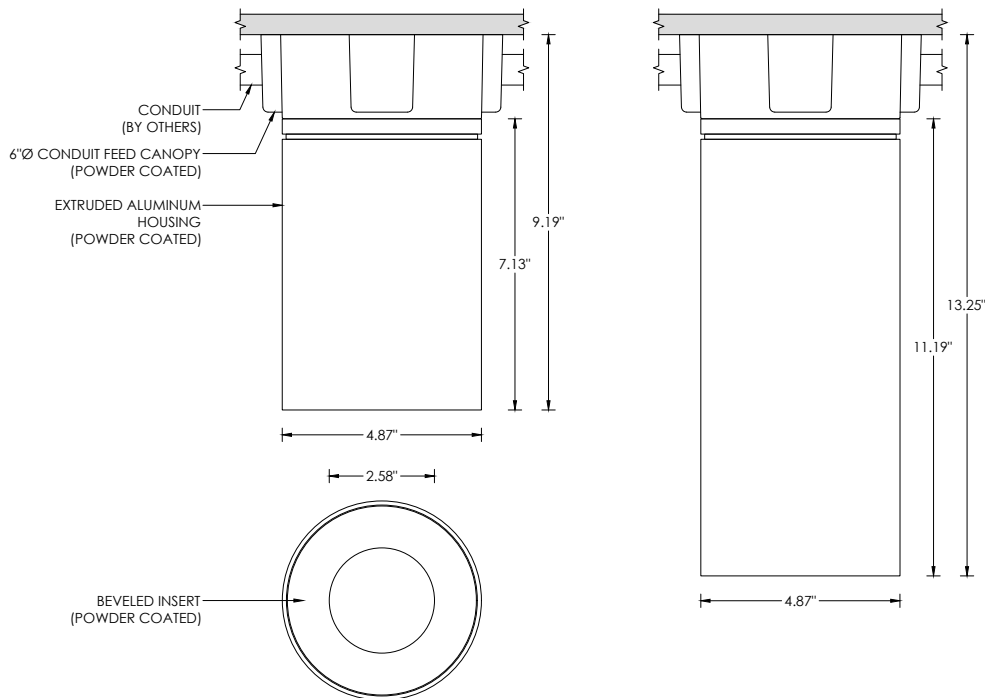

CONDUIT FEED CANOPY MOUNTING OPTIONS

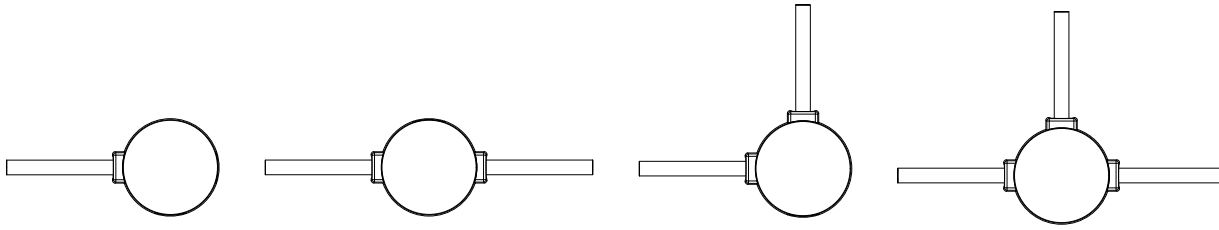

CONDUIT COVER
3 PROVIDED WITH EACH
CONDUIT FEED CANOPY

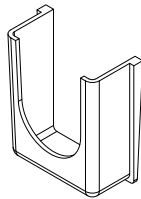

BLANK
2 PROVIDED WITH EACH
CONDUIT FEED CANOPY

