



3G-4RLI-WC

3.5" RECESSED LINEAR
WALL TO CEILING
TUNABLE WHITE & RGBW



- 3.5" aperture with one piece extruded aluminum housing
- Seamless wall to ceiling illumination
- Proprietary alignment mechanism
- Suitable for drywall, wood, and grid ceiling applications
- LED system with performance up to 147 lumens per watt
- Extruded acrylic lens available in flush, 1" and 2" drop lens options
- 1% dimming standard with several driver options



ORDERING INFORMATION

PROJECT:	<input type="text"/>	TYPE:	<input type="text"/>
CATALOG #:	<input type="text"/>	DATE:	<input type="text"/>

CAT. NO	LED SOURCE	LUMEN OUTPUT	CRI	VOLTAGE
3G-4RLI-WC	TW - TUNABLE WHITE (2700K-6500K)	L250 - LOW OUTPUT (250 LM/FT) ² L500 - MEDIUM OUTPUT (500 LM/FT) L750 - HIGH OUTPUT (750 LM/FT) L1000 - VERY HIGH OUTPUT (1000 LM/FT) ³ LC___ - CUSTOM OUTPUT (SPECIFY LM/FT)*	S80 - 83+ CRI H90 - 93+ CRI ¹	UNV - 120/277V
	RGBW - INFINITE COLOUR ¹ (3500K WHITE)	*Specify custom lumen outputs in 50lm increments (ie: LC600, LC650, LC700) Custom output cannot exceed LC1000 Lumen outputs suitable for white LED source only		

DRIVER	FLANGE TYPE (WALL)	FLANGE TYPE (CEILING)	LENS OPTION
DO1 - 0-10V (100-0.1%) DALI - DALI (eidoLED, 100-1%) DMX - DMX (eidoLED, 100-0%) ¹ DHLT - LUTRON T SERIES (100-1%) (2 CHANNEL TUNABLE WHITE)	WXTR - TRIMLESS (MUD-IN DRYWALL) WFX - FLANGELESS	CXTR - TRIMLESS (MUD-IN DRYWALL) CFX - FLANGELESS GCX - GRID CEILING (UNIVERSAL MOUNT) *	FL - FLUSH DD1 - 1" DROP LENS ⁴ DD2 - 2" DROP LENS ⁴
		*Universal mounting brackets used for all grid ceiling types only. See mounting section for details	

OPTIONS	LENGTH (FEET)
EMC - EMERGENCY CIRCUIT ⁵ CP - CHICAGO PLENUM	W ___' x C ___' (WALL TO CEILING) * W ___' x C ___' x W ___' (WALL TO CEILING TO WALL)
*Available in 1' increments only	

¹ RGBW LED source available with S80 (83 +CRI) and DMX driver option only. Not available with asymmetric optic or EM options
² L250 (250LM/FT) not available in 2' and 3' lengths (Please specify LC400 for 2' and 3' fixture length when outputs lower than 500LM/FT are required)
³ L1000 (1000LM/FT) not available for H90 (93+ CRI)
⁴ DD1 (1" drop lens) and DD2 (2" drop lens) available with straight run type only
⁵ EMC (emergency circuit) options available for tunable white LED source only. Not available with RGBW

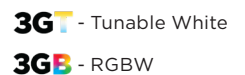

JANUARY 2, 2024





3G-4RLI-WC

3.5" RECESSED LINEAR - WALL TO CEILING
TUNABLE WHITE & RGBW

PERFORMANCE CHART BASED ON 4' LENGTH WITH FLUSH LENS (TUNABLE WHITE AND 83+ CRI)

COLOR TEMP	DELIVERED LUMENS (LM/FT)	SYSTEM WATTS (W/FT)	EFFICACY (LPW)
2700K	250	1.9	126
	500	3.8	121
	750	5.8	119
	1000	8.0	118
3500K	250	1.9	135
	500	3.8	130
	750	5.8	127
	1000	8.0	123
6500K	250	1.9	147
	500	3.8	145
	750	5.8	138
	1000	8.0	132
EFFICACY (LPW) ADJUSTMENT FACTOR	CRI	Multiplier	
	93+	0.88	

PHOTOMETRY BASED ON 4' LENGTH (83+ CRI AND 3500K SOURCE)

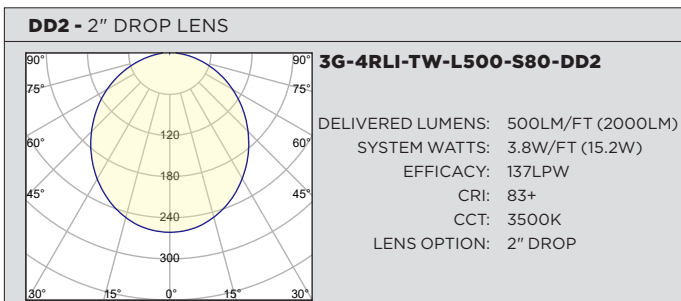
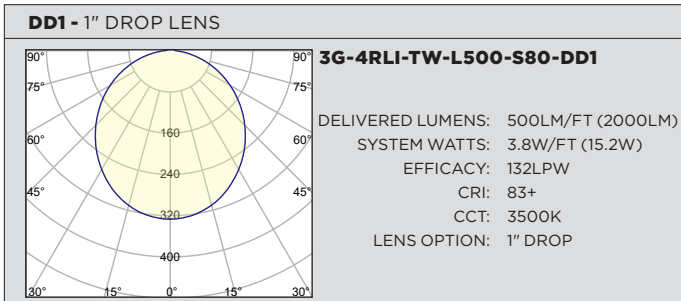
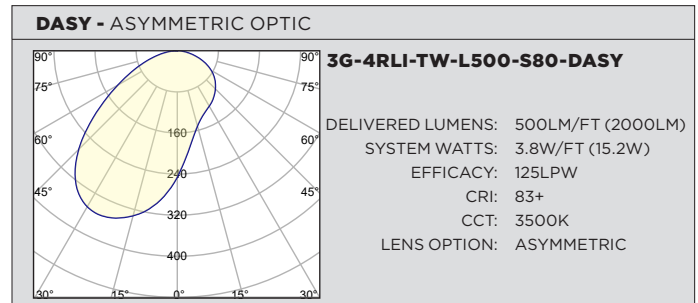
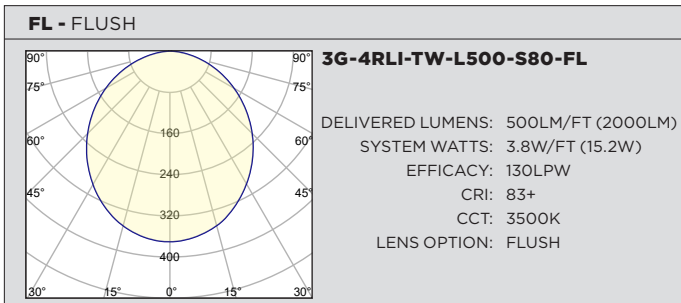

PERFORMANCE CHART BASED ON 4' LENGTH (RGBW WITH 83+ CRI AND 3500K SOURCE)

COLOR TEMP	DELIVERED LUMENS (LM/FT)	SYSTEM WATTS (W/FT)	EFFICACY (LPW)
3500K	250	2.2	119
	500	4.6	113
	750	7.8	96
	1000	11.3	89

LUMINOUS INTENSITY PER LED	RGB	INTENSITY Min - Max (mcd)
	RED	355 - 805
	GREEN	710 - 1400
	BLUE	140 - 355

PHOTOMETRY BASED ON 4' LENGTH (83+ CRI AND 3500K SOURCE)

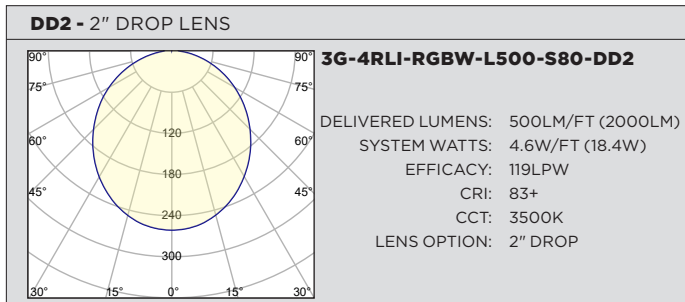
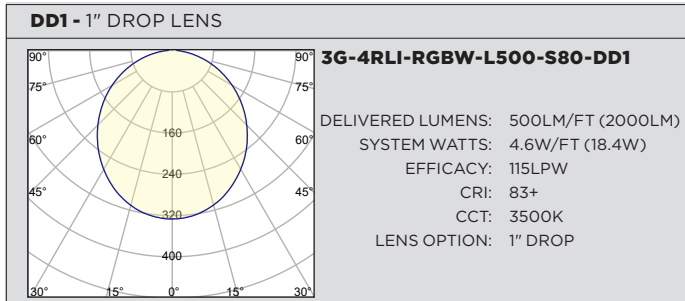
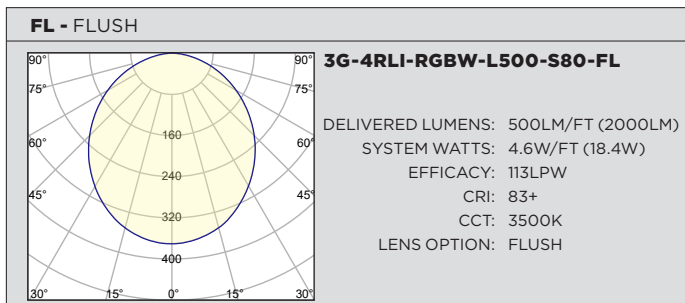

TECHNICAL**HOUSING**

Extruded aluminum housing with 3.5" aperture
Individual units and continuous runs available in 1' increments
Trim flange with matte white powder coated finish and minimal 0.400" overlap
Trimless model features a satin coat mudding flange for seamless ceiling
24-gauge LED reflector with high reflectance white powder coated finish
Standard polyester powder coated matte white finish

OPTICS

Extruded, satin acrylic lens designed for optimal performance and glare control. Up to 8' continuous
Lens options include flush, 1" and 2" drops with illuminated end caps for all drop lenses
High performance asymmetric optics available

ELECTRICAL

Luminaires are pre-wired with factory installed quick connects and branch circuit wiring
Multiple driver options available for tunable white LED system
DMX driver option for RGBW system with RDM control and 100-0% dimming range
All drivers are integral and easily accessible through luminaire aperture

LED SYSTEM FOR TUNABLE WHITE (TW)

Proprietary LED system with color consistency <3 SDCM
2700K-6500K CCT range
Standard 83+CRI. Optional 93+CRI. (R9 value of 56 for 93+CRI)
L90 >60,000 hours
5 Year Warranty

LED SYSTEM FOR RGBW

Proprietary LED system with color consistency <3 SDCM
White LED available in 35K with 83+ CRI
L80 >72,000 hours
Red (335-805 mcd)
Green (710-1400 mcd)
Blue (140-355 mcd)
5 Year Warranty

MOUNTING

Housing suspended via 1/4" threaded rod or suspension cables
Trimless fixture designed for use in drywall, mud-in ceiling applications
Flangeless fixture designed for use in wood ceilings

LISTING

ETL listed and tested to cUL standards. Suitable for dry and damp locations

WARRANTY

5 Year Warranty on LED and drivers
Manufacturer 1 Year Warranty for defects in material and workmanship under normal use
Ambient temperature at fixture should not exceed 25°C

DRAWINGS AND DIMENSIONS HARD CEILING

CXTR - TRIMLESS CEILING

WXTR - TRIMLESS WALL

CFX - FLANGELESS CEILING

WFX - FLANGELESS WALL

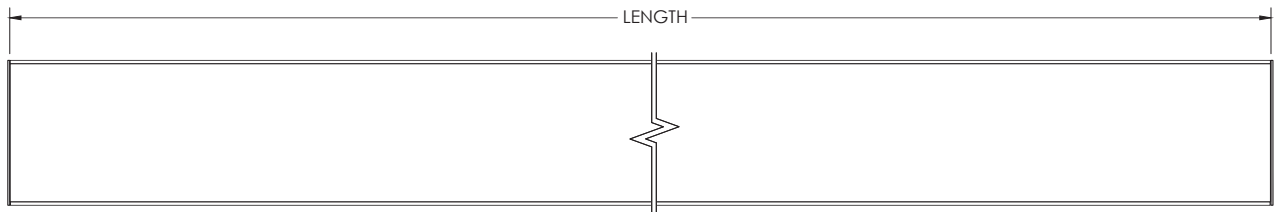
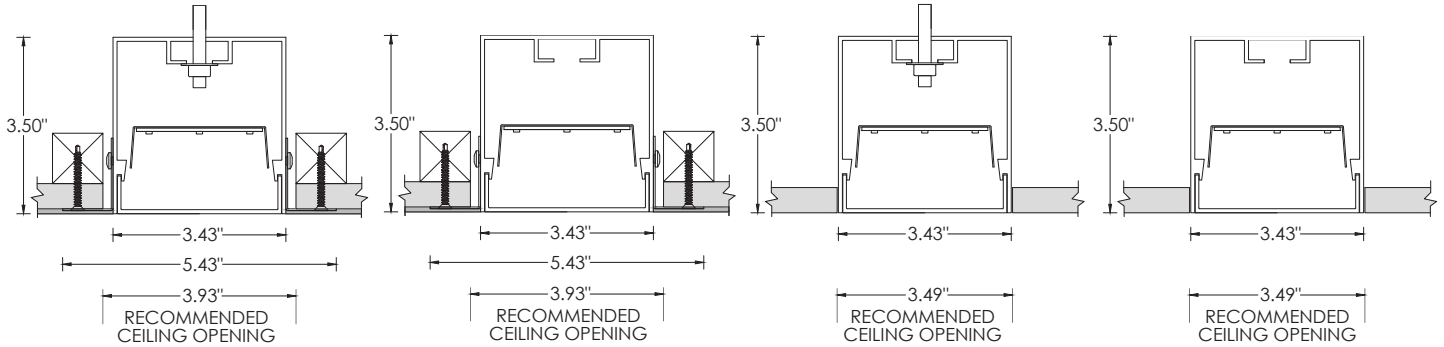

LENS OPTION

FL - FLUSH

DD1 - 1" DROP

DD2 - 2" DROP

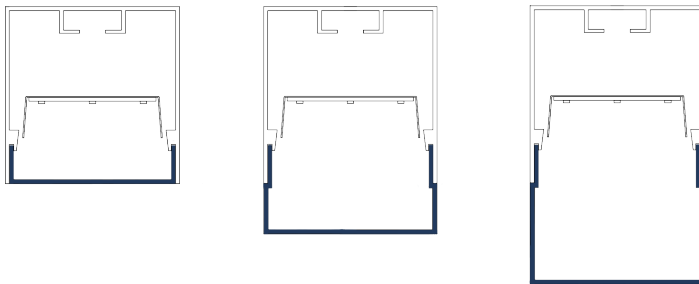

MOUNTING DETAILS HARD CEILING

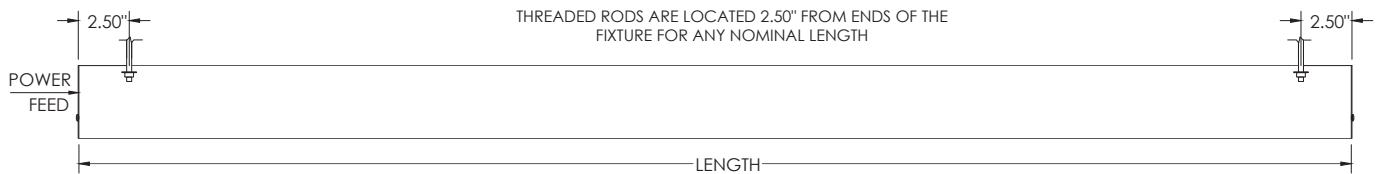

DRAWINGS AND DIMENSIONS GRID CEILING

9L - 9/16" LAYIN

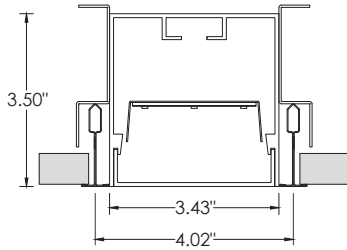

9TG - 9/16" TEGULAR

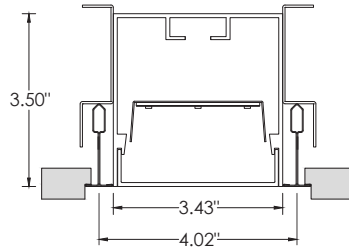

15L - 15/16" LAYIN

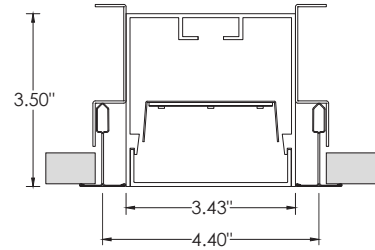

15TG - 15/16" TEGULAR

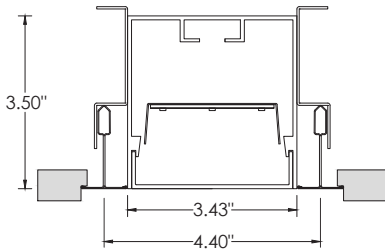

9ST - 9/16" SLOT TEE TEGULAR

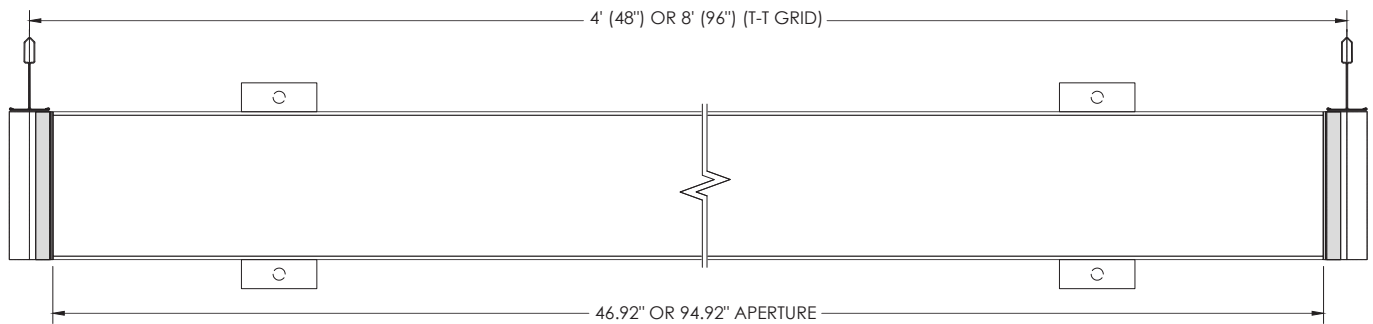
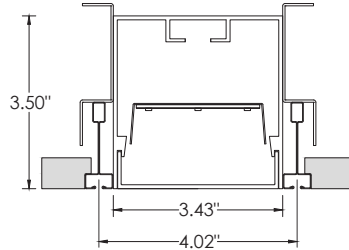

MOUNTING DETAILS GRID CEILING

